



EUROPEAN COMMISSION  
DIRECTORATE-GENERAL  
CLIMATE ACTION  
**Directorate B - European & International Carbon Markets**

Guidance Document n°2  
on the harmonized free allocation methodology for the EU-ETS post  
2012

**Guidance on allocation methodologies**

*Final version issued on 14 April 2011 and updated on 29 June 2011*

## Table of contents

1	Introduction.....	3
1.1	Status of the Guidance Documents.....	3
1.2	Background of the CIM Guidance Documents .....	3
1.3	Use of the Guidance documents .....	4
1.4	Additional guidance.....	4
1.5	Scope of this guidance document and overview of allocation methods.....	5
2	Split installation into sub-installations .....	9
2.1	Assessing product benchmark sub-installations .....	9
2.2	Assessing heat benchmark sub-installations .....	10
2.3	Assessing fuel benchmark sub-installations .....	12
2.4	Assessing process emissions sub-installations .....	13
3	Determination of allocation per sub-installation .....	16
3.1	Product benchmark sub-installation .....	16
3.2	Heat benchmark sub-installation .....	19
3.3	Fuel benchmark sub-installation .....	20
3.4	Process emissions sub-installation .....	21
4	Annual basic, preliminary and final allocation per installation .....	23
4.1	Basic allocation .....	23
4.2	Preliminary allocation .....	23
4.3	Final allocation .....	23
5	Determination of initial capacity according to Art. 7.3 of the CIMs.....	25
6	Determination of historical activity level .....	27
6.1	Choice of baseline period.....	27
6.2	Default method.....	27
6.3	Start of operation after 1 January 2005.....	29
6.4	Changes in capacity .....	33
7	Additional examples .....	47
7.1	Example 1: Installation without product benchmarks and with different carbon leakage statuses .....	47
7.2	Example 2: Combined heat and power (CHP) .....	48
7.3	Example 3: Complex example.....	49

# 1 Introduction

## 1.1 Status of the Guidance Documents

This guidance document is part of a group of documents, which are intended to support the Member States, and their Competent Authorities, in the coherent implementation throughout the Union of the new allocation methodology for Phase III of the EU ETS (post 2012) established by the Decision of the Commission 2011/278/EU on “Transitional community-wide and fully harmonised implementing measures pursuant to Article 10a(1) of the EU ETS Directive” (CIMs) and developing the National Implementation Measures (NIMs). The guidance does not represent an official position of the Commission and is not legally binding.

This guidance document is based on a draft provided by a consortium of consultants (Ecofys NL, Fraunhofer ISI, Entec). It takes into account the discussions within several meetings of the informal Technical Working Group on Benchmarking under the WGIII of the Climate Change Committee (CCC), as well as written comments received from stakeholders and experts from Member States. It was agreed that this guidance document reflects the opinion of the Climate Change Committee, at its meeting on 14 April 2011.

The guidance papers do *not* go into detail regarding the procedures that Member States apply when issuing greenhouse gas emissions permits. It is acknowledged that the approach to setting the installation boundaries laid down in GHG emissions permits differ between Member States.

## 1.2 Background of the CIM Guidance Documents

Specific topics were identified within the CIMs which deserve further explanation or guidance. The CIM guidance documents intend to address these issues as specific and clear as possible. The Commission considers it necessary to achieve the maximum level of harmonisation in the application of the allocation methodology for phase III.

The CIM guidance documents aim at achieving consistency in the interpretation of the CIMs, to promote harmonisation and prevent possible abuse or distortions of competition within the Community. The full list of those documents is outlined below:

In particular:

- Guidance document n. 1 – general guidance: this guidance gives a general overview of the allocation process and explains the basics of the allocation methodology.
- Guidance document n. 2 – guidance on allocation methodologies: this guidance explains how the allocation methodology works and its main features.
- Guidance document n. 3 – data collection guidance: this guidance explains which data are needed from operators to be submitted to the Competent Authorities and how to collect them. It reflects the structure of the data collection template provided by the EC.

- Guidance document n. 4 – guidance on NIMs data verification: this guidance explains the verification process concerning the data collection for the National Implementation Measures<sup>1</sup>.
- Guidance document n. 5 – guidance on carbon leakage: it presents the carbon leakage issue and how it affects the free allocation calculation.
- Guidance document n. 6 – guidance on cross boundary heat flows: it explains how the allocation methodologies work in case of heat transfer across the 'boundaries' of an installation.
- Guidance document n. 7 – guidance on new entrants and closures: this guidance is meant to explain allocation rules concerning new entrants as well as the treatment of closures.
- Guidance document n. 8 – guidance on waste gas and process emission sub-installation: this document provides for explanation of the allocation methodology concerning process emission sub-installation, in particular, concerning the waste gas treatment.
- Guidance document n. 9 – sector specific guidance: this guidance provides for detailed description of the product benchmarks as well as the system boundaries of each of the product benchmarks listed within the CIMs.

This list of documents is intended to complement other guidance papers issued by the European Commission related to Phase III of EU ETS, in particular:

- Guidance on Interpretation of Annex I of the EU ETS Directive (excl. aviation activities), and
- Guidance paper to identify electricity generators

References to Articles within this document generally refer to the revised EU ETS Directive and to the CIMs.

### **1.3 Use of the Guidance documents**

The guidance documents give guidance on implementing the new allocation methodology for Phase III of the EU ETS, as from 2013: the Member States may use this guidance when they perform the data collection pursuant to Article 7 of the CIMs in order to define the complete list of installations as well as to calculate any free allocation to be determined for the National Implementing Measures (NIMs) pursuant to Article 11(1) of the Directive 2003/87/EC.

### **1.4 Additional guidance**

Next to the guidance documents, additional support to the Member State authorities is provided in the form of a telephone helpdesk, and the EC-website, with list of guidance

---

<sup>1</sup> Article 11 of Directive 2003/87/EC

documents, FAQs and useful references,  
[http://ec.europa.eu/clima/policies/ets/benchmarking\\_en.htm](http://ec.europa.eu/clima/policies/ets/benchmarking_en.htm) .

### **1.5 Scope of this guidance document and overview of allocation methods**

Four allocation methodologies have been developed in order to calculate the allocation of free allowances to installations. The methodologies have the following strict order of applicability:

- Product benchmark
- Heat benchmark
- Fuel benchmark
- Process emissions approach

Table 1 provides an overview of the conditions relating to each allocation methodology.

Section 2 presents the split into sub-installations, and sections 3.1 to 3.4 detail each methodology using simple examples. The final steps of allocation are then explained in sections 4 to 6, and additional examples given in section 4.

**Table 1: Conditions related to the four allocation methodologies**

Methodology	Value	Conditions	Relevant emissions
Product benchmark	See list in Annex I of CIMs	A product benchmark is available in Annex I of the CIMs.	Emissions within system boundaries of product
Heat benchmark	62.3 Allowances / TJ of heat consumed	<p>Heat should meet all six conditions below in order to be covered by a heat benchmark sub-installation (article 3(c)):</p> <ul style="list-style-type: none"> <li>- The heat is measurable (as transported through identifiable pipelines or ducts using a transfer medium, a heat meter is or could be installed)</li> <li>- The heat is used for a purpose (production of products, mechanical energy, heating, cooling)</li> <li>- The heat is not used for the production of electricity</li> <li>- The heat is not produced within the boundaries of a nitric acid product benchmark (article 10(6)).</li> <li>- The heat is not consumed within the system boundaries of a product benchmark</li> <li>- Heat is: <ul style="list-style-type: none"> <li>▪ consumed within the ETS installation’s boundaries and produced by an ETS-installation;</li> </ul> </li> </ul> <p>OR</p> <ul style="list-style-type: none"> <li>▪ produced within the ETS installation’s boundaries and consumed by a non-ETS installation or other entity for a purpose other than electricity production</li> </ul> <p><i>Heat produced outside of ETS is not eligible for free allocation.</i>  <i>Operators trading heat (neither producing it nor consuming it) will receive no free allocation for this heat. More information regarding cross-boundary heat flow is provided in Guidance Document 6.</i></p>	Emissions relating to the production of consumed “measurable” heat, not covered by a product benchmark
Fuel benchmark	56.1 Allowances / TJ of fuel used	<p>Fuel input should meet all four conditions below in order to be covered by a fuel benchmark sub-installation (article (3(d)):</p> <ul style="list-style-type: none"> <li>- The fuel is not consumed within the boundaries of a product or heat benchmark sub-installation</li> <li>- The fuel is not consumed for the production of electricity</li> <li>- The fuel is not flared, except in the case of safety flaring.</li> <li>- The fuel is combusted for: <ul style="list-style-type: none"> <li>▪ direct heating or cooling production, without heat transfer medium</li> </ul> </li> </ul> <p>OR</p> <ul style="list-style-type: none"> <li>▪ the production of mechanical energy which is not used for the production of electricity</li> </ul> <p>OR</p> <ul style="list-style-type: none"> <li>▪ the production of products</li> </ul>	Emissions originating from the combustion of fuels, not covered by product or heat benchmark.

**Table 1. Conditions related to the four allocation methodologies (continued)**

Methodology	Value	Conditions	Relevant emissions
Process Emissions Approach	0.97 Allowance s/t of process emissions	<p>Process emissions should meet both conditions below in order to be covered by a process emissions benchmark sub-installation (article 3(h)):</p> <ul style="list-style-type: none"> <li>- The emissions are not covered by a product benchmark or by any of the other fall-back approaches;</li> <li>- The emissions considered “process emissions” are: <ul style="list-style-type: none"> <li>▪ non-CO<sub>2</sub> greenhouse gas emissions listed in Annex I of Directive 2003/87/EC occurring outside of the system boundaries of a product benchmark listed in Annex I of the CIMs</li> <li>▪ CO<sub>2</sub> emissions as a result of any of the activities listed below; Only CO<sub>2</sub> as direct and immediate result of the production process or chemical reaction can be considered. CO<sub>2</sub> from the oxidation of CO or other incompletely oxidized carbon is not covered regardless if this oxidation takes place in the same or a separate technical unit. Example: CO<sub>2</sub> from the oxidation of CO in an open furnace cannot be regarded as process emission under this category (but may fall under the third category if the criteria are matched).</li> <li>▪ Emissions stemming from the combustion of incompletely oxidized carbon produced as a result of any of the following activities for the purpose of the production of measurable heat, non-measurable heat or electricity MINUS emissions from the combustion of an amount of natural gas with equal energy content as those gases, taking into account differences in energy conversions efficiencies (<i>see Guidance Document 8 on waste gases for additional information on the definition of waste gases and corresponding allocation</i>).</li> </ul> </li> </ul> <p>Activities:</p> <ul style="list-style-type: none"> <li>○ The chemical or electrolytic reduction of metal compounds in ores, concentrates and secondary materials;</li> <li>○ The removal of impurities from metals and metal compounds;</li> <li>○ The thermal decomposition of carbonates, excluding those for the flue gas scrubbing;</li> <li>○ Chemical synthesis where the carbon bearing material participates in the reaction, for a primary purpose other than the generation of heat;</li> <li>○ The use of carbon containing additives or raw materials for a primary purpose other than the generation of heat;</li> <li>○ The chemical or electrolytic reduction of metalloid oxides or non-metal oxides such as silicon oxides and phosphates.</li> </ul>	All “process emissions” within installation not covered by previous approaches. Non-eligible emissions are excluded.



## 2 Split installation into sub-installations

The first step in calculating the allocation of an installation is to define so-called sub-installations. A sub-installation means all inputs, outputs and corresponding emissions related to a specific allocation regime. The boundaries of a sub-installation are not necessarily defined by boundaries of physical process units. An installation can be split into a maximum number of  $n+6$  sub-installations,  $n$  being the number of product benchmarks applicable within the installation (*See CIMs for formal definitions of four types of sub-installations: a product benchmark sub-installation (Art. 3(b)), a heat benchmark sub-installation (Art. 3(c)), a fuel benchmark sub-installation (Art. 3(d)) and a process emissions sub-installation (Art. 3(h)); see also Guidance Document 1 for guidance on sub-installations*).

Care should be taken that sub-installations do not overlap. Inputs, outputs and corresponding emissions should not be covered by more than one sub-installation and each sub-installation will receive allocation according to one and only one allocation methodology. (*See Guidance Document 3 on Data Collection for more guidance on the attribution of inputs and outputs*)

Installations are split into sub-installations via the following steps.

### 2.1 Assessing product benchmark sub-installations

#### Step 1a Define one or more product benchmark sub-installations (if applicable)

For each product benchmark that applies, a product benchmark sub-installation should be defined. For each product benchmark sub-installation:

- Identify the system boundaries (*see Guidance Documents 3 on data collection and 9 on sector specific guidance for details on boundaries*).
- Look up relevant product benchmark values
- Look up carbon leakage status in annex I and II to the CIMs (with corresponding Carbon Leakage Exposure Factor *CLEF*) (*For additional guidance on the 'carbon leakage status', see Guidance Document 5 on carbon leakage*)

Note that product benchmark values  $BM_p$  are constant over the years  $k$  (2013-2020), while the exposure factor *CLEF* may change over the years  $k$  depending on the carbon-leakage status (if the product is deemed to be exposed to a risk of carbon leakage, it will in principle remain constant, if it is not it will decline over the years; *see Guidance Document 5 on Carbon Leakage for more information*).

Step 1b Attribute relevant inputs and outputs (This should only apply in case not all emissions are covered by product benchmark sub-installations.)

Attribute all relevant inputs (e.g. raw materials, fuel, heat, and electricity input required for making the product) and outputs.

(e.g. production activity, heat, process emissions, waste gases) to the sub-installation for each year in the period 2005 and 2010 that the installation has been operating.

If there is more than one product benchmark applicable in one installation, one should make sure that inputs and outputs of each sub-installation are not attributed twice. When there are only product benchmark sub-installations in an installation, it is not necessary to calculate precisely the amount of fuel and heat attributed to each sub-installation, as the allocation will be based only on the amount of product produced for each product.

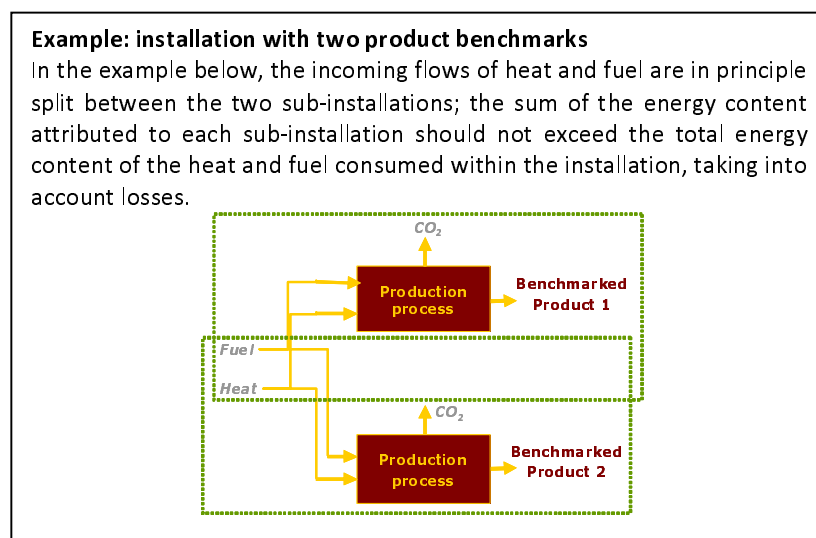

## 2.2 Assessing heat benchmark sub-installations

Step 2a Define one or two heat benchmark sub-installations (if applicable)

One or two heat benchmark sub-installations<sup>2</sup> need to be defined if:

- The installation consumes measurable heat outside the boundaries of a product benchmark sub-installation, provided that:

<sup>2</sup> Normally, one heat benchmark sub-installation covers all relevant heat production and/or consumption as specified in this section. Only in case the heat production and/or consumption serves both processes of sectors/ products deemed and not deemed to be exposed to a significant carbon leakage risk, two heat benchmark sub-installations are needed (please consult guidance paper No. 5 on carbon leakage for more information).

- the heat is produced by the installation itself or by another ETS installation
  - the heat is not produced within the boundaries of a nitric acid product benchmark
  - the heat is not used to produce electricity
- The installation exports measurable heat to a non-ETS installation or entity provided that:
    - the heat is not produced within the boundaries of a nitric acid product benchmark
    - the heat is not used to produce electricity

**Measurable heat flows** have all of the following characteristics:

- They are **net** meaning that the heat content in the condensate or transfer medium returning to the heat supplier is subtracted. For determination of measurable heat data see Guidance Document 3 on data Collection.
  - The heat flows **are transported through identifiable pipelines or ducts**
- AND
- The heat flows **are transported using a heat transfer medium**, e.g. steam, hot air, water, oil, liquid metals or salts
- AND
- The heat flows **are or could be measured by a heat meter** (where a heat meter is any device that can measure the amount of energy produced based upon flow volumes and temperatures)

#### **No distinction between different origins of heat**

No distinction is made between heat from different sources (e.g. produced from different fuels, produced by boilers or CHP, heat as a by-product of a benchmarked production process, etc.)

In principle, heat is eligible for free allocation if it can be regarded as covered by the ETS and if it is not produced via electric boilers. This is in particular likely to be the case for measurable heat directly linked (combustion process or exothermic production process) to source streams which are contained in the monitoring plan (MP) of an installation covered by the EU ETS. Exceptions to this rule are the following:

- The export or consumption of heat produced in the nitric acid production process is not eligible for free allocation as this heat is already taken into account by the nitric acid benchmark.
- The consumption of heat produced by a non-ETS plant or unit (not covered by a GHG permit) is not eligible for free allocation.
- The consumption of heat used for electricity generation is not eligible for free allocation.

Whether one or two heat benchmark sub-installations need to be defined, depends on the carbon leakage status of the products for which the heat is consumed: heat consumed within the production process of a product deemed exposed to carbon leakage must be

included in a different sub-installation than heat consumed within the production process of a product not deemed exposed to carbon leakage (see *Guidance Document 5 on carbon leakage* for more details on this topic).

*Step 2b Attribute relevant inputs and outputs (if applicable)*

Attribute all relevant inputs (*like heat data*) and outputs (*like emissions relating to the heat production*) to each sub-installation for each year<sup>3</sup> in the period 2005 and 2010 that the installation has been operating.

The heat consumed by a heat benchmark sub-installation is measured at the heat consuming production lines, and not at the heat producing facilities. For heat exported from a heat benchmark sub-installation to non-ETS entity the point of measurement is however at the exit of the heat producing facilities.

## **2.3 Assessing fuel benchmark sub-installations**

*Step 3a Define one or two fuel benchmark sub-installations<sup>4</sup> (if applicable)*

One or two fuel benchmark sub-installations need to be defined if, as indicated in

---

<sup>3</sup> Measurable heat for heating up offices and canteens: this heat is normally included within the system boundaries of product BM. In case no product BM sub-installation can be listed within a certain installation, then inputs, outputs and emissions related to those devices shall be accounted for within the heat BM sub-installation. CL exposure, depending on the most relevant production process within the installation.

<sup>4</sup> Depending on the carbon leakage status, see explanation in section 2.2 and guidance document No. 5 on carbon leakage

Table 1, the fuel benchmark methodology should be used in case the installation combusts fuel outside the boundaries of a product benchmark for:

- Direct heating or cooling production without heat transfer medium
- Or the production of products
- Or the production of mechanical energy, which is not used for the production of electricity

Provided that:

- The fuel is not consumed for the production of electricity
- The fuel is not flared, unless it is for safety flaring; Safety flaring refers to the combustion of pilot fuels and highly fluctuating amounts of process or residual gases in a unit open to atmospheric disturbances which is explicitly required for safety reasons by relevant permits for the installation. Please consult guidance document No. 8 on waste gases for further explanations of this definition.

*Note: Fuel used for the purpose of waste treatment (without recovery of measurable heat) cannot be considered eligible as fuel benchmark sub-installation as it does not relate to any of the three production activities listed above (direct heating/ cooling, production of products, production of mechanical energy).*

Whether one or two fuel benchmark sub-installations need to be defined, depends on the carbon leakage status of the products for which the fuel is combusted: fuel combusted within the production process of a product deemed to be exposed to a risk of carbon leakage must be included in a different sub-installation than fuel combusted within the production process of a product not deemed exposed to carbon leakage. *See Guidance Document 5 on carbon leakage for more details on this topic.*

Step 3b Attribute relevant inputs and outputs (if applicable)

Attribute all relevant inputs (*combusted fuel*) and outputs (*emissions relating to the combusted fuel*) to each sub-installation for each year in the period 2005 and 2010 that the installation has been operating.

## **2.4 Assessing process emissions sub-installations**

Step 4a Define one or two process emissions sub-installations<sup>5</sup> (if applicable)

One or two process emissions sub-installations need to be defined if the installation has process emissions outside the boundaries of a product benchmark, where process emissions are defined as:

- Type a: non-CO<sub>2</sub> greenhouse gas emissions listed in Annex I of Directive 2003/87/EC; N<sub>2</sub>O is the only non-CO<sub>2</sub> greenhouse gas included in EU-ETS for non-benchmarked

---

<sup>5</sup> Depending on the carbon leakage status, see explanation in section 2.2 and guidance document No. 5 on carbon leakage

products (only for emissions from the production of glyoxal and glyoxylic acid). N<sub>2</sub>O has a Global Warming Potential of 310.

- Type b: CO<sub>2</sub> emissions as a result of any of the activities listed in Table 2 (and *not* as result from the combustion of incompletely oxidized carbon produced in these activities; as such 'indirect CO<sub>2</sub> emissions' are in principle covered by type c);
- Type c: Emissions stemming from the combustion of incompletely oxidized carbon produced as a result of any of the activities listed in Table 2 for the purpose of the production of measurable heat, non-measurable heat or electricity MINUS emissions from the combustion of an amount of natural gas with equal energy content as those gases; *See Guidance Document 8 on Waste Gases and process emissions sub-installation for additional information on the definition of waste gases, the distinction between emissions of type b and c and the corresponding allocation*

Whether one or two sub-installations based on the process emissions approach need to be defined depends on the carbon leakage status of the products whose production process emits the process emissions: emissions from the production process of a product deemed to be exposed to a risk of carbon leakage must be included in a different sub-installation than emissions from the production process of a product not deemed to be exposed to a risk of carbon leakage (see *Guidance Document 5 on carbon leakage* for more details on this topic).

**Table 2. Definitions and examples of activities covered by the process emissions sub-installations definition (Art. 3 (h) of the CIMs)**

<b>Definition of activity</b>	<b>Example</b>
Chemical or electrolytic reduction of metal compounds in ores, concentrates and secondary materials	Production of copper from copper carbonate minerals
Removal of impurities from metals and metal compounds	Emissions from the oxidation of impurities of scrap emitted as part of a recycling process
Decomposition of carbonates, excluding those for the flue gas scrubbing	Production of magnesia.
Chemical synthesis where the carbon bearing material participates in the reaction, for a primary purpose other than the generation of heat	Acrylic acid production, acetylene production (partial oxidation), acrylonitrile production (ammoxidation), formaldehyde production (partial oxidation/dehydrogenation)
Use of carbon containing additives or raw materials for a primary purpose other than the generation of heat	Emissions from the oxidation of organic additives to increase the porosity of ceramics products
Chemical or electrolytic reduction of metalloid oxides or non-metal oxides such as silicon oxides and phosphates	Production of silicium, reduction of phosphate ore

For the fourth and fifth category it needs to be assessed whether there is another purpose of the use of carbon containing material other than the production of heat and if yes, which one has to be regarded as the primary purpose.

*Example: The production of lime as a high temperature process requires the use of significant amounts of fuels for the production of the necessary heat for the chemical reaction. In case the lime is used for purification processes (e.g. for the production of sugar) requiring an excess of CO<sub>2</sub>, the combustion CO<sub>2</sub> serves an additional purpose. However, given the high energy intensity of the process, the heat production has to be regarded as the primary purpose of the fuel combustion and the resulting emissions cannot be covered by a process emissions sub-installation<sup>6</sup>.*

#### Step 4b Attribute relevant inputs and outputs

Attribute all relevant inputs (data relating to the material from which the process emissions originate, if applicable) and outputs (e.g. process emissions, data relating to the use of the waste gases including emissions from their combustion) to each sub-installation for each year in the period 2005 and 2010 that the installation has been operating.

---

<sup>6</sup> Independent from these considerations, emissions from the decomposition of carbonates occurring during the production of lime products used in the same installation for purification processes should not be regarded as process emissions sub-installation and should not be subject to monitoring and reporting. The production of precipitated calcium carbonate (PCC) is not regarded as purification process and therefore lime produced and used for PCC production should be subject to the product benchmark "lime". Furthermore, these emissions should be subject to monitoring and reporting in accordance with the applicable rules for ETS installations.

### 3 Determination of allocation per sub-installation

After definition of the relevant sub-installations, the allocation to the sub-installations can be calculated. Each sub-installation will make use of one and only one allocation methodology. This chapter describes the application of the different allocation methodologies.

*For each sub-installation, the historical activity level should be determined in accordance with the approach outlined in Chapter 6.*

#### 3.1 Product benchmark sub-installation

Figure 1 shows a product benchmark sub-installation. The dotted line shows the system boundaries of the sub-installation. The allocation is determined based on the production of the benchmarked product.

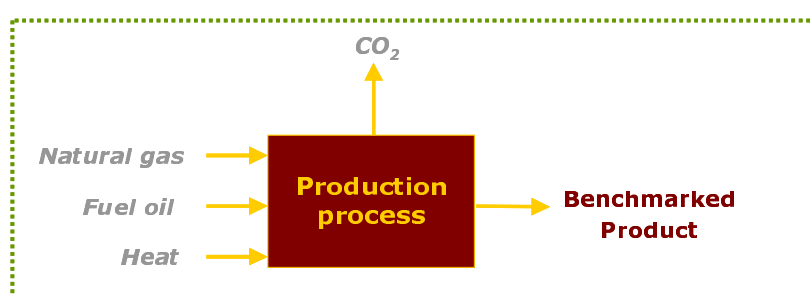

Figure 1 Product benchmark sub-installation

##### Step 1c Determine historical activity level

The historical activity levels ( $HAL_p$ ) of each product benchmark sub-installation are expressed as the production volumes of the benchmarked product. Product definitions and units of production are defined in the CIMs, and explained in *Guidance Document 9 on sector-specific guidance*.

##### Step 1d Calculate preliminary free allocation

The preliminary annual amount of allocation for each product benchmark sub-installation is:

$$F_{sub\_p} = BM_p \times HAL_p$$

With:

- $F_{sub\_p}$  Annual preliminary allocation for product p (expressed in EUAs)
- $BM_p$  Product benchmark value for product p (expressed in EUAs / unit of product)
- $HAL_p$  Historical activity level of product p, i.e. the median annual production in the baseline period as determined and verified in the baseline data collection



(expressed in unit of product) See *Guidance Document 9 with Sector Specific Guidance for the unit of production to be used for different products.*

#### Exchangeability between fuel and electricity

In processes where either fuel or electricity can be used to produce heat or mechanical energy for the production of an equivalent product (e.g. mineral wool), the choice of energy carrier should not influence the determination of the benchmark value. In these cases indirect emissions have been taken into account in the determination of the benchmark value. Figure 2 illustrates how the benchmark curve (yellow curve) takes into account both direct (blue bar) and indirect (orange bar) emissions to define the benchmark value (in green).

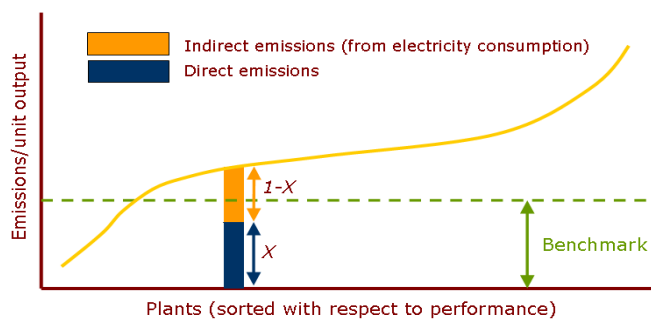

**Figure 2** Definition of benchmarks in the case of exchangeability between fuel and electricity

Allocation should however be based on direct emissions only. In order to achieve consistency between the benchmarks and the allocation, for the product benchmarks concerned (as determined by Annex I (2) of the CIMs), the preliminary allocation is calculated using a ratio of direct and total emissions (see equation here-after). *Guidance document 9 on sector-specific guidance provides additional guidance on sectors for which this applies.*

If the benchmark is based on direct and indirect emissions, the preliminary annual amount of allocation is determined as follows:

$$F_p = \frac{Em_{direct} + Em_{NetHeatImport}}{Em_{direct} + Em_{NetHeatImport} + Em_{Elec}} \cdot BM_p \cdot HAL_p$$

With:

- $F_p$  : Annual preliminary allocation for a product benchmark sub-installation (expressed in EUAs).
- $BM_p$  : Product benchmark (expressed in EUAs / unit of product).
- $HAL_p$  : Historical activity level, i.e. the median annual production in the baseline period as determined and verified in the baseline data collection (expressed in units of product).

$Em_{direct}$  : Direct emissions within the system boundaries of the product benchmark sub-installation over the baseline period. These are the total accumulative emissions over the entire baseline period (2005-2008 or 2009-2010) irrespective of any changes in capacity, activity or operation that may have occurred. The direct emissions include the emissions due to the production of heat within the same ETS installation that is consumed within the system boundaries of the benchmarked production process. Direct emissions should (by definition) exclude any emissions from electricity generation or net heat export/import from other ETS installations or non-ETS entities.

$Em_{NetHeatImport}$  : Emissions from any net measurable heat import from other ETS installations and non-ETS entities over baseline period by the product benchmark sub-installation. Irrespective of where and how the heat is produced, these emissions expressed in tonne CO<sub>2</sub> are calculated as follows:

$$Em_{NetHeatImport} = Net\ Heat\ Import \cdot 62.3$$

Where *Net Heat Import* is the total net measurable heat import from other ETS installations and non-ETS entities over the baseline period by the product benchmark sub-installation, expressed in TJ. This is the accumulative net heat import over the entire baseline period (2005-2008 or 2009-2010) irrespective of any changes in capacity, activity or operation that may have occurred.

$Em_{Elec}$  : Indirect emissions from electricity consumption within the system boundaries of product benchmark sub-installation over the baseline period. Irrespective of where and how the electricity is produced, these emissions expressed in tonne CO<sub>2</sub> are calculated as follows:

$$Em_{Elec} = Elec.\ use \cdot 0.465$$

Where *Elec.use* is the electricity consumption within the system boundaries of the production of the benchmarked product over the baseline period, expressed in MWh. This is total electricity consumption over the entire baseline period (2005-2008 or 2009-2010) irrespective of any changes in capacity, activity or operation that may have occurred.

#### *Import of heat from non-ETS installations*

The consumption of heat produced either by a non-ETS installation or by a sub-installation producing products covered by the nitric acid benchmarks is not eligible for free allocation. Therefore, when a product benchmark sub-installation imports heat produced by a non-ETS installation, the allocation relating to this amount of heat should be subtracted from the total allocation. See *Guidance Document 6 on cross-boundary heat flows for more guidance on this topic*.

### 3.2 Heat benchmark sub-installation

Figure 3 shows a heat benchmark sub-installation. The dotted line shows the system boundaries of the sub-installation. The allocation is determined based on the measurable heat consumption.

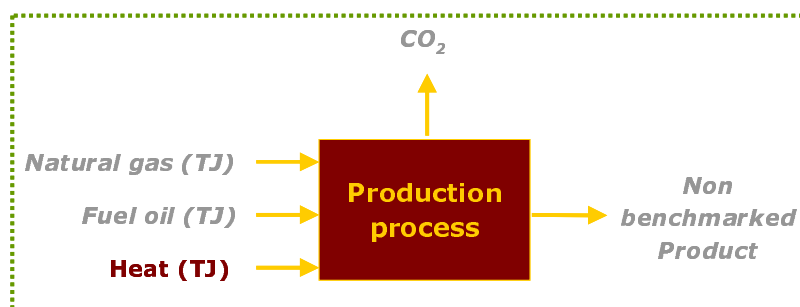

Figure 3 Heat benchmark sub-installation.

#### Step 2c Determine historical activity level

The annual historical activity level of a heat benchmark sub-installation ( $HAL_h$ ) is expressed in TJ and is the sum of:

- Consumption of net measurable heat outside the boundaries of a product benchmark produced by the installation itself or another ETS installation provided that the heat is not produced within the boundaries of a nitric acid product benchmark or used to produce electricity.
- Net measurable heat production exported to non-ETS consumers provided that the heat is not produced within the boundaries of a nitric acid product benchmark or used to produce electricity. *See Guidance Document 6 on cross-boundary heat flows for more details on this topic.*

In principle, no distinction is made between heat from different sources (see section 2, step 2a for further explanations)

If no historic measurable heat data is available, the historical activity level will be calculated using proxy data. *See Annex B of Guidance Document 3 on Data Collection for more guidance on the use of proxy data.*

#### Step 2d Calculate preliminary free allocation

Calculate the preliminary annual allocation for each heat benchmark sub-installation using the following equation:

$$F_{sub\_h} = BM_h \times HAL_h$$

with

$F_{sub\_h}$	Preliminary annual allocation for sub-installation in year k based on the heat benchmark (expressed in EUAs)
$BM_h$	Heat benchmark; set at 62.3 tCO <sub>2</sub> / TJ.

**Only net heat flows are of relevance meaning that the heat content in the condensate or transfer medium returning to the heat supplier is subtracted.**

In case of heat export to non-ETS consumers, the net heat export will be used instead of the net heat consumption, and the allocation will be distributed to the heat producer. As a general rule, a non-ETS plant is not deemed to be exposed to a risk of carbon leakage. In case the operator has reason to believe that the non-ETS heat consumer is deemed to be exposed to a risk of carbon leakage, he must provide sufficient proof of this to the Competent Authorities. *See Guidance Document 6 on cross-boundary heat flows for more details on this topic.*

### 3.3 Fuel benchmark sub-installation

Figure 4 shows a fuel benchmark sub-installation. The dotted line shows the system boundaries of the sub-installation. The allocation is determined based on the fuel consumption.

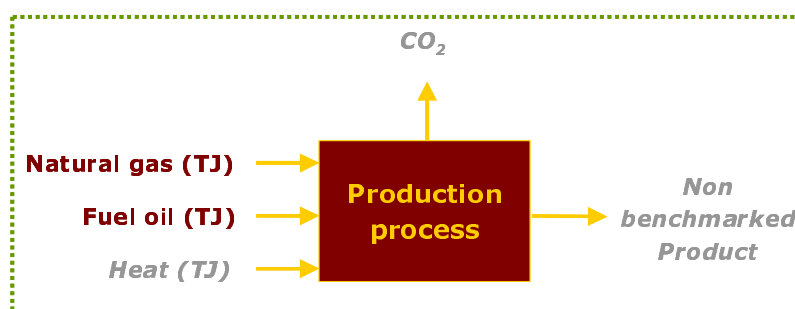

**Figure 4** Fuel benchmark sub-installation

#### Step 3c Determine historical activity level

The annual historical activity level ( $HAL_f$ ) of a fuel benchmark sub-installation is the consumption of fuel outside the boundaries of a product benchmark (expressed in TJ), provided that the fuel is used for the production of products, mechanical energy or heating/cooling and not for the production of electricity or measurable heat production. The annual historical activity level includes the amount of fuel used for safety flaring. Fuel used for other purposes (e.g. waste treatment outside the boundaries of a product benchmark) is not considered.

If a fuel as part of the total fuel input into a process is not used for a combustion process to produce non-measurable heat as it is used for other chemical reactions producing waste

gases (e.g. chemical reduction of metal ores, chemical syntheses, etc.), this amount of fuel must not be considered for the determination of the Historical consumption of fuels of the fuel sub-installation(s). *For more guidance on this topic, see Guidance Document 8 on waste gases.*

Step 3d Calculate preliminary free allocation

Calculate the preliminary annual amount of allocation for each fuel benchmark sub-installation *i* using the following equation:

$$F_{sub\_f} = BM_f \times HAL_f$$

with

- $F_{sub\_f}$  Preliminary annual allocation for the sub-installation (expressed in EUAs)
- $BM_f$  Fuel benchmark; set at 56.1 tCO<sub>2</sub> / TJ.
- $HAL_f$  Historical consumption of fuels of the sub-installation (expressed in TJ)

### 3.4 Process emissions sub-installation

Figure 5 shows a process emissions sub-installation. The dotted line shows the system boundaries of the sub-installation. The allocation is determined based on the historical process emissions.

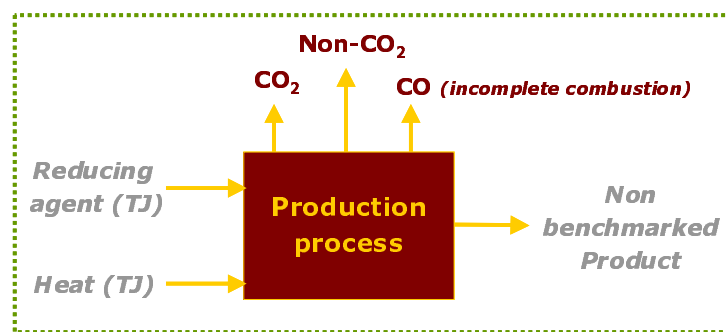

Figure 5 Process emissions sub-installation

Step 4c Determine historical activity level

The historical activity level ( $HAL_e$ ) (expressed as tCO<sub>2</sub>e) of a process emission sub-installation is the sum of:

- non-CO<sub>2</sub> greenhouse gas emissions listed in Annex I of Directive 2003/87/EC which are not covered by a product benchmark or by any other fall back approaches (type a)
- CO<sub>2</sub> emissions as a result of any of the activities listed in step 4.a (type b, see section 2)

- Emissions stemming from the combustion of incompletely oxidized carbon produced as a result of any of the activities listed in step 4.a (see section 2) for the purpose of the production of measurable heat, non-measurable heat or electricity MINUS emissions from the combustion of an amount of natural gas with equal energy content as those gases, taking into account differences in energy conversions efficiencies. The allocation for incompletely oxidized carbon in fact constitutes the allocation for waste gases (type c)

*For additional guidance on process emissions sub-installations and waste gases, we refer to Guidance Document 8.*

Step 4d Calculate preliminary free allocation

Calculate the allocation for each sub-installation for which a historical emissions approach is applicable using the following equation:

$$F_{sub\_e} = PRF \times HAL_e$$

with

$F_{sub\_e}$	Preliminary annual allocation for the sub-installation
$PRF$	Reduction factor, which is set at 0.97 (dimensionless).
$HAL_e$	Historical “process emissions” of the sub-installation (expressed in tCO <sub>2</sub> eq)

For type b process emissions sub-installations the historical activity levels is based on the CO<sub>2</sub> emissions for the baseline period. In case of mixes of incompletely oxidized carbon (e.g. CO) and CO<sub>2</sub>, the historical activity level should be based on results from measurements of the share of CO<sub>2</sub> in the total carbon content of the gas in accordance with applicable European standards covering the relevant baseline period. In case such historical measurement data are not available, a default value based on the assumption that 75% of the carbon content of the gas-mix is fully oxidised (CO<sub>2</sub>) should be applied.

In the case of process emissions resulting from the combustion of waste gases, see *Guidance Document 8 on waste gases*.

## 4 Annual basic, preliminary and final allocation per installation

### 4.1 Basic allocation

The basic total annual amount of emission allowances per installation is calculated by taking the sum of allocations to sub-installations, not considering carbon leakage exposure factors is equal to:

$$F_{inst}^{basis} = \sum_i F_{sub}^i$$

$F_{inst}^{basis}$  Total basic allocation to the installation  
 $F_{sub}^i$  Annual allocation for sub-installation  $i$

Although this amount does not necessarily reflect the preliminary amount allocated to installations, it should be included in the NIMs as it will be used for the determination of the cross-sectoral reduction factor

### 4.2 Preliminary allocation

The preliminary total annual amount of emission allowances per installation is calculated by multiplying the allocation with the carbon leakage exposure factor of each sub-installation.

$$F_{inst}(k) = \sum_i (F_{sub}^i \times EF_{sub}^i(k))$$

With

$F_{inst}(k)$  Preliminary total allocation to the installation in year  $k$   
 $F_{sub}^i$  Allocation for sub-installation  $i$   
 $EF_{sub}^i(k)$  Carbon Leakage Exposure Factor of sub-installation  $i$  in year  $k$ .

### 4.3 Final allocation

For installations not classified as “electricity generator” the final total annual amount of allowances is determined by:

$$F_{inst}^{final}(k) = F_{inst}(k) \times CSF(k)$$

With

$F_{inst}^{final}(k)$  Final total amount of allocation to the installation in year  $k$   
 $CSF(k)$  Cross-sectoral correction factor in year  $k$  (if necessary)

For installations classified as “electricity generator” the final total annual amount of allowances is determined by:

$$F_{inst}^{final}(k) = F_{inst}(k) * LRF(k)$$

With

$k$  Year  $k$

$F_{inst}^{final}(k)$  Final total amount of allocation to the installation in year  $k$

$F_{inst}(k)$  Final preliminary amount of allocation to the installation in year  $k$

$LRF(k)$  Linear Reduction Factor (see table below)

Year	Linear reduction factor
2013	1.0000
2014	0.9826
2015	0.9652
2016	0.9478
2017	0.9304
2018	0.9130
2019	0.8956
2020	0.8782



## 5 Determination of initial capacity according to Art. 7.3 of the CIMs

The operators must determine and submit the initial installed capacity of a sub-installation for:

- All product benchmark sub-installations
- All sub-installations which had a significant change in capacity during the baseline period.

This chapter explains how to determine the capacity of a product benchmark sub-installation with no significant capacity change during the baseline period, based on Article 7(3) of the CIMs. For the determination of sub-installations which had a significant change in capacity during the baseline period, see section 6.4 of this document.

The capacity determined in accordance with the CIMs for the calculation of the number of free allowances, for the calculation of standard capacity utilisation factors (SCUFs), or for the evaluation of the significant changes needs to be distinguished from any references to capacities in permits.

The definition of capacities for different sub-installations covers the same activities as historical activity levels and should be expressed in the same unit. See Chapter 3 for the definition of historical activity levels and in addition Table 1 for an overview of conditions that heat, fuel and process emissions should comply to in order to be taken into account in the determination of historical activity levels and capacities of heat benchmark, fuel benchmark and process emissions sub-installations, respectively.

Depending on the data availability the capacity should be defined according to method 1 or method 2.

### **Method 1 – determining the capacity based on historical data**

When this is possible, the capacity should always be based on historical data of production during the period from 1<sup>st</sup> January 2005 to 31<sup>st</sup> December 2008. If no other reference in Annex I to the CIMs is given, the capacities refer to tonnes of product produced expressed as saleable (net) production and to 100% purity of the substance concerned (for details please also consult guidance paper No.9 on sector-specific guidance)

The operator will identify the 2 highest monthly production volumes in the period from 1<sup>st</sup> January 2005 to 31<sup>st</sup> December 2008. The average of these 2 values will be taken as the initial monthly capacity of the plant, without further corrections or adjustments. The initial installed capacity of the plant will be this value multiplied by 12 months.

### **Method 2 – determining the capacity based on experimental verification**

Method 2 will apply only if the highest monthly production volumes in the period from 1<sup>st</sup> January 2005 to 31<sup>st</sup> December 2008 cannot be calculated because data on operation during this period is missing (i.e. because the installation operated less than 2 months in the relevant baseline period or records were lost); in this case, the operator should explain the circumstances that led to that choice within the methodology report, subject to verification by the verifier. The final opinion would always be the one of the CA. If the reason is estimated by the CA to be insufficient, then conservative estimates of production (e.g. sales figures, extrapolated data from other months or estimates based on installation-level data broken down to sub-installation level) will be used to determine the capacity (see Guidance Document 3 on data collection for more guidance on conservative estimates).

In that case, in the course of the baseline data collection, the operator will conduct an experimental verification of the sub-installation's capacity under the supervision of an independent third party. The verification will relate to a 48 hours continuous test, carried out following the operational patterns of normal operation of the installation. The independent third party will be present during this test and will compare the production level and the parameters relating to the produced product to typical values in the sector, as well as to available data, if any, relating to previous production patterns at the installation. In particular, parameters relating to the quality of the produced product will be taken into account to ensure that the quality of the production during the test is in line with the quality of the product normally produced at the installation.

The initial monthly capacity of the plant will be the average production during the 2 days of experimental verification multiplied by 30 days. The initial installed capacity of the plant will be this value multiplied by 12 months.

For the determination of the initial capacity to calculate the SCUFs for the product benchmarks, it is recommended not to apply method 2 given the limited added value of the results.

## 6 Determination of historical activity level

This chapter describes how to determine the historical activity level used in the determination of free allocation. Section 6.1 describes which years should form the baseline period. Section 6.2 describes the way to determine the historical activity levels for sub-installations that had no change in operation or significant change in capacity. Sections 6.3 and 6.4 give guidance to the definitions of changes in operations and significant changes in capacity respectively and explain how the historical activity level should be determined in such cases.

### 6.1 Choice of baseline period

In principle, the baseline period is either 2005-2008 or 2009 and 2010 (Art. 9.1 of the CIMs). The chosen baseline period should in principle be the one that leads to the highest historical activity levels. The way to determine the historical activity levels is explained in sections 6.2 to 6.4.

The baseline period that leads to the highest historical activity level may differ from one sub-installation to another. The same baseline period must however be chosen for the entire installation including all sub-installations.

### 6.2 Default method

The default way to determine the historical activity level of a sub-installation is to take the median value of the annual activity levels of the sub-installation in the baseline period: 2005-2008 or 2009-2010, so

$$HAL = \text{median}_{2005-2008} (\text{Annual activity levels})$$

OR

$$HAL = \text{median}_{2009-2010} (\text{Annual activity levels})$$

If the installation has not been operated occasionally according to Art. 9.8 of the CIMs (as successfully demonstrated by the operator to the CA), all years in the baseline period in which the *installation* has been operating for at least 1 day should be taken into account (See Art. 9.6).

Consequently, in some cases years of zero activity levels for a sub-installation have to be considered if at least one other sub-installation has been operating. This is particularly relevant for installations that have produced different benchmarked products in the same production line. The following examples demonstrate that the standard methodology also works for such cases. See next section on guidance on the determination of HAL in case installations have not been operating for at least 1 day during the baseline period.

### Example 1

A glass factory has a glass production line in which both coloured and colourless glass bottles can be produced. Suppose that the chosen baseline period is 2005-2008. The two types of products are covered by two different product benchmarks. The following activity levels were realized in 2005-2008.

**Table 3: Historical activity levels of a glass-producing installation**

	2005	2006	2007	2008
Coloured glass bottles	800	800	0	0
Colourless glass bottles	0	0	800	800

The installation is covered by two product benchmarks, hence, two sub-installations should be applied. In order to determine the HAL, the median over the baseline period in which the **installation** has been operating for at least one day should be taken for each product benchmark, following Article 9(6):

$$HAL_{\text{coloured glass}} = \text{median}_{2005-2008} (800, 800, 0, 0) = 400$$

$$HAL_{\text{colourless glass}} = \text{median}_{2005-2008} (0, 0, 800, 800) = 400$$

The sum of the HALs for the individual sub-installations is 800 and reflects the historical activities of the glass factory.

Please, note that, without a physical change, provisions concerning significant capacity changes within the baseline period referred to in article 9.9 do not apply. Provisions on the cessation of operation (Art. 22 of the CIMs) do not apply as well to incumbents.

### Example 2

A paper mill has a paper production line in which 3 types of paper can be produced: newsprint, uncoated fine paper and coated fine paper. The three types of products are covered by three different product benchmarks. The following activity levels were realized in 2005-2008.

**Table 4: Historical activity levels of a paper-producing installation**

	2005	2006	2007	2008
Newsprint	800	0	500	700
Uncoated fine paper	200	600	0	300
Coated fine paper	0	400	500	0

The installation is covered by three product benchmarks, hence, three sub-installations should be applied. Suppose that the chosen baseline period is 2005-2008. In order to determine the HAL, the median over the baseline period in which the **installation** has been operating for at least one day should be taken for each product benchmark, following Article 9(6):

$$HAL_{newsprint} = \text{median}_{2005-2008} (800, 0, 500, 700) = 600$$

$$HAL_{uncoated\ fine} = \text{median}_{2005-2008} (200, 600, 0, 300) = 250$$

$$HAL_{coated\ fine} = \text{median}_{2005-2008} (0, 400, 500, 0) = 200$$

As in the first example, the results reflect the products levels very well.

Like in example 1, without a physical change, provisions concerning significant capacity changes within the baseline period referred to in article 9.9 do not apply. Provisions on the (partial) cessation of operation (Art. 22 and 23 of the CIMs) do not apply before 30 June 2011 to incumbents, but they apply to the (partial) cessation of operation between 1 July 2011 and 31 December 2012.

*Example:*

*A glass factory has two different production lines, one for coloured glass and one for colourless glass. The coloured glass line is shut down in 2012 but kept in reserve as from 2012 (no physical change).*

	2005	2006	2007	2008	2009	2010	2011	2012	2013
<i>Coloured glass</i>	800	800	800	800	800	800	800	0	0
<i>Colourless glass</i>	800	800	800	800	800	800	800	800	800

*The glass factory is allocated as an incumbent for 2 sub-installations, both with a HAL of 800. Pursuant article 23 the operator has to notify the CA that he has partially ceased operations in a given calendar year and the activity level of the sub-installation is clearly reduced to 0. Hence allocation for the sub-installation "coloured glass" is to be adjusted to zero as the installation has partially ceased operation.*

### 6.3 Start of operation after 1 January 2005

This section explains how to calculate the HAL for an installation that did not operate during the entire baseline period, either because it started normal operation after the start of the baseline period. This section does not apply to sub-installations which started normal operation after 1 January 2005 if the installation already operated on 1 January 2005 (for such cases please consult section 6.4 on capacity changes).

The start of normal operation is determined in accordance with Article 3 n of the CIMs. For this purpose, the operator determines the earliest continuous 90 days period during which the activity level – aggregated over the 90 days period – is at least 40% of the design capacity. The continuous 90 days period is to be understood as period of 90 consecutive days in which the whole installation operated each day. The start of normal operation is the first day of this period. In case the sector's usual production cycle does not foresee such continuous 90 days periods, the sector-specific production cycles are added to a 90 days period.

The situation of interrupted operation during the baseline period leading to zero production of the whole installation in at least one calendar year is treated similarly.

For installations that by their nature operate only occasionally, e.g. installations that are operating on a seasonal schedule or installations that are kept in reserve or on standby, *all years* of the chosen baseline period after the start of normal operation should be taken into account, including calendar years with less than 1 day production (article 9(8)).

For installations that by their nature do not operate only occasionally, only years in which the *installation* has been operating for at least one day should be used in calculating the Historical Activity Level (HAL). That means that in some cases years of zero activity levels of a sub-installation have to be considered if at least one other sub-installation has been operating. This is in fact what is done in examples 1 to 3 in the previous section.

#### Case 1 – Installations which operated for at least 2 calendar years

If an installation using the baseline 2005 to 2008 has started normal operation as a whole before or on the 1<sup>st</sup> January 2007, it has been operating at least 2 calendar years and therefore the HAL will be calculated with the standard formula. All years (from the start of normal operation) in which the installation has operated at least 1 day will be taken into account in the calculation of the HAL.

The HAL will in this case be the median of the activity level (AL) of all years in which the installation has been operating, as illustrated by examples a to c.

*Example a* – the installation has been operating for at least 1 day in each year of the baseline period.

HAL = median (AL<sub>2005</sub>, AL<sub>2006</sub>, AL<sub>2007</sub>, AL<sub>2008</sub>)

*Example b* – the installation has not been operating at all in 2006 because of an accident or because of maintenance reasons (AL<sub>2006</sub>=0).

HAL = median (AL<sub>2005</sub>, AL<sub>2007</sub>, AL<sub>2008</sub>)

*Example c* – the installation, as a whole, started its operations on the 31<sup>st</sup> October 2006; the HAL should be calculated based on activity levels of years 2006, 2007 and 2008 only.

HAL = median (AL<sub>2006</sub>, AL<sub>2007</sub>, AL<sub>2008</sub>)

### Case 2 – Installations which operated for less than 2 calendar years

If an installation, as a whole, has started normal operation after 1<sup>st</sup> January 2007 (e.g. the installation started its normal operations on the 2<sup>nd</sup> or later), it has been operating less than 2 calendar years in the baseline period 2005 to 2008. To calculate the HAL, the installation will have two possibilities:

- Either choose the 2009 to 2010 baseline

Or

- Calculate the HAL of each sub-installation as follows (in line with Article 9(6) of the CIMs):

$$HAL = Capacity \times RCUF$$

Where

*Capacity* is the initial installed capacity, calculated as indicated in chapter 5 of this document

*RCUF* is the relevant capacity utilization factor (see hereafter)

If an installation, as a whole, has started normal operation after 1<sup>st</sup> January 2009 (e.g. the installation started its normal operations on the 2<sup>nd</sup>), HAL needs to be calculated according to the second approach.

The **initial installed capacity** is determined by the methodologies described in section 5. The standard method (determination based on the two highest monthly activity volumes) applies when data for the two highest monthly activity levels are available. This is considered to be the case when the normal operation of an (incumbent) installation started on or before 30 June 2011. In other cases (when the start of normal operation is after 30 June 2011), the initial capacity should be determined by experimental verification (method 2, see section 5 for more details). Independent from the method used, the initial capacity has to be determined before 30 September 2011.

In order to allow the Competent Authorities to determine the **RCUF** in line with Article 18(2), the installation will provide “duly substantiated and independently verified information on the installation’s intended normal operation, maintenance, common production cycle, energy efficient techniques and typical capacity utilization in the sector concerned compared to sector-specific information.” The operator will provide the relevant capacity utilization factor (RCUF) of each sub-installation as a % of the capacity. Information on the installation’s normal operation, maintenance and production cycles available from the determination of the capacity should be used.

For the determination of the RCUF, following aspects have to be considered:

- The installation’s intended normal operation: expected production volumes based on the design capacity, guaranteed on the basis of technical documentation/datasheets by the supplier), and operational hours (use of information from business plans,

permits, etc.). If available, production data should be used to validate these expected production volumes.

- Maintenance: The availability of the production lines has to be estimated (based on information from business plans, permits, relevant technical documentation, etc.). The estimated downtimes are to be taken into account when estimating the expected production levels.
- Common production cycle: Based on information from business plans, permits, relevant technical documentation, etc. it needs to be checked if continuous operations are technically possible, intended according to the demand for the products (e.g. seasonal or non-seasonal demand) and legally possible (limitations in the relevant permits).

For heat and fuel benchmark sub-installations, in addition, energy efficient techniques should be considered when the heat or fuel consumption is estimated based on projections for production figures.

For process emission sub-installations, the emission intensity of input materials as well as greenhouse gas efficient techniques (e.g. low-carbon input qualities, abatement techniques) should be considered when the process emissions are estimated based on projections for production figures.

If needed, the CA should adjust the preliminary value of the RCUF assuming that such greenhouse gas efficient techniques were used.

The resulting RCUF should be compared against the typical capacity utilisation in the sector concerned. Any major deviation needs to be justified. No values for the RCUF equal or higher than 100% must be accepted.

The calculation will be verified by an independent third party.



### Summary

The use of different allocation methods for different dates for the start of normal operation is summarised in the following table, for installations operating at least 1 day every year after the start of normal operation:

<b>Start of normal operation</b>	<b>Baseline period</b>	<b>Historical activity level</b>
01/01/2007 and before	choice of the operator: <ul style="list-style-type: none"><li>• 2005 - 2008 or</li><li>• 2009 - 2010</li></ul>	<ul style="list-style-type: none"><li>• Median value (Art. 9 (1));</li><li>• Median value (Art. 9 (1));</li></ul>
02/01/2007 - 31/12/2008	choice of the operator: <ul style="list-style-type: none"><li>• 2005 - 2008 or</li><li>• 2009 - 2010</li></ul>	<ul style="list-style-type: none"><li>• Capacity times utilisation (Art. 9 (6))</li><li>• Median value (Art. 9 (1));</li></ul>
01/01/2009	<ul style="list-style-type: none"><li>• 2009 – 2010</li></ul>	<ul style="list-style-type: none"><li>• Median value (Art. 9 (1));</li></ul>
02/01/2009 – 30/06/2011	<ul style="list-style-type: none"><li>• (2009 – 2010)</li></ul>	<ul style="list-style-type: none"><li>• Capacity times utilisation (Art. 9 (6))</li></ul>

## **6.4 Changes in capacity**

Article 9(9) of the draft Commission Decision provides for an approach for calculating the historical activity level of a sub-installation in the case of a significant capacity change in the period between 1 January 2005 and 30 June 2011 occurred. In this context, the start of changed operation is the relevant date. Only significant capacity changes which have been identified - in accordance with the methodology described in this section - before 30 September 2011 should be considered. This includes the determination of the new capacity by this date. Significant capacity changes which have been identified or for which the new capacity has only been determined after this date should be treated by the rules for new entrants where appropriate.

The approach determines that the historical activity level is to be determined according to the general rules disregarding the significant capacity change first. The historical activity level of the added/reduced capacity is determined separately. The total historical activity level of the sub-installation having had a significant change will be the sum of the two historical activity levels.

The details of this approach will be described step-by-step here-after and illustrated on the basis of two examples. Although only the case of product benchmark sub-installations is dealt with in this section, this approach applies to all sub-installations: product benchmark sub-installations, heat benchmark sub-installations, fuel benchmark sub-installations and process emissions-related sub-installations.

**Step 1: Has the sub-installation had a significant capacity extension/reduction in the period from 1 January 2005 to 30 June 2011?**

Any operator claiming the application of Article 9(9) will first have to determine whether his investment in the period January 2005 to June 2011 actually led to a significant capacity extension/reduction in the sense of the draft Commission Decision.

The 2 main ways or possibilities to demonstrate a significant capacity extension/reduction are laid down in Article 3(i) of the draft Commission Decision and are the following:

*Possibility 1*

The sub-installation's initial installed capacity as determined in accordance with Article 7(3) of the draft Commission Decision has known a significant increase/decrease, whereby

- (i) one or more identifiable physical changes relating to its technical configuration and functioning other than the mere replacement of an existing production line have taken place, and
- (ii) the sub-installation can be operated at a capacity that is at least 10% higher (in case of extensions) or lower (in case of reductions) compared to the initial installed capacity of the sub-installation before the change

*Possibility 2*

Alternatively, the sub-installation's initial installed capacity as determined in accordance with Article 7(3) of the draft Commission Decision is also considered having significantly increased/decreased, if

- (i) one or more identifiable physical changes relating to its technical configuration and functioning other than the mere replacement of an existing production line have taken place, and
- (ii) the sub-installation to which the physical changes relate has a significantly higher (in case of extensions) or lower (in case of reductions) activity level resulting in an additional allocation of emission allowances calculated on the basis of the rules laid down in the draft Commission Decision of more than 50 000 allowances per year. These 50 000 allowances represent at least 5% of the preliminary annual number of emission allowances allocated free of charge for this sub-installation before the change.

The percentage values (10% under option 1 and 5% under option 2) refer to the capacity of the entire sub-installation. Example: A refinery extends the capacity of one of its CWT units by 30%. This does not necessarily constitute a significant capacity increase as the total CWT of the refinery product benchmark sub-installations needs to be considered.

***Step 1a: The operator needs to provide evidence that one or more physical change(s) have been made to the sub-installation***

Common feature of both possibilities above is the physical change. In the context of the definition of significant capacity extensions/reductions, such physical changes must be understood as modifications of production processes and the equipment required, and the different subparts of the definition should be interpreted as:

1. The necessary condition is the *physical nature* of the change related to the technical configuration and functioning. This excludes all types of merely organizational or operational changes (e.g. longer daily operation hours, higher speed of rotating kiln, application of new process control software, change in major process parameters such as pressure, temperature).
2. The *impact* of the physical change on the *technical configuration and functioning* constitutes the sufficient condition. Any physical change without such impact (e.g. a repaint coating of the outer face of a kiln) does not match the definition as there needs to be a clear causality link between the physical change(s) and the change in capacity. In other words, only physical changes allowing for changes in throughputs could lead to a significant change of capacity.
3. Furthermore, the mere replacement of an existing production line cannot be considered in the context of the definition of significant capacity extensions. This includes the replacement of parts of a production line without impacts on the technical configuration and functioning (e.g. replacement of a pre-heater with the same performance). But, in case of higher maximum throughput of the production line after the replacement, this change could in principle constitute a physical change leading a significant capacity extension (provided the quantitative criteria are met).

Physical changes exclusively aiming at improving the energy efficiency of a sub-installation or the improvement or installation of an end of pipe abatement technology to reduce process emissions should not be regarded as physical change leading to a significant capacity reduction. Nevertheless, the operator needs to report such physical changes to the Competent Authority in the context of the data collection and to provide evidence on the purpose of the physical change.

*Example*

*A chemical installation consumes heat and produces no benchmarked products. The installation receives free allocation for the heat consumption via the heat benchmark. The installation made a physical change during the baseline period that improved its energy efficiency and led to 10.5% lower heat consumption (activity level) at equal production. Although the activity level of the installation decreased significantly as a result of a capacity change, this will not be regarded as a significant capacity reduction, provided that the*

*operator can provide sufficient evidence for the fact that the production did not decrease as result of the physical change.*

Following the need for a clear causality link between the physical change(s) and the change in capacity, physical changes allowing for higher throughputs cannot lead to a significant capacity reduction and vice versa.

*Example:*

*The operator of an installation installed an additional production line in December 2008 which constitutes a physical change. For economic reasons, the production however decreased by 30% in the 6 months after the start of changed operation of the sub-installation. This could in principle indicate a capacity reduction. Nevertheless, as there is no causality link between the physical change and the potential capacity decrease, this change cannot be regarded as significant capacity reduction. However, if at a later stage the production level increases, the start of changed operation would be determined in accordance with the methodology described below under 'step 1b'.*

After the physical change there is in principle no time limit for the capacity increase. However, only physical changes after 1 January 2005 can be considered. Furthermore, only physical changes can be considered which have not already been considered for calculating free allocation for the post 2012 trading period (e.g. as they did not lead to a previous significant capacity change). In other words: Further significant capacity changes require additional physical changes which take place after the start of changed operation of the previous significant capacity change.

*Example:*

*A ceramics producer operating a single furnace may have installed a second furnace in 2009 and thereby doubled its theoretical capacity. Due to a specific market situation, the furnace was however not operated and the criteria for significant capacity increases were therefore not met and the operator does not receive additional allowances on the basis of Art. 9 (9). If now the ceramics producer would start using the new furnace in 2013, a related production increase of more than 10% would qualify as new-entrant.*

**Step 1b: The operator demonstrates that:**

- ***the physical change(s) led to a change in capacity of at least 10%***

**OR**

- ***the physical change(s) led to a change in allocation to the sub-installation of more than 50 000 allowances and the difference represents more than 5% of the amount of allowances calculated irrespective of the physical change***

*Possibility 1: - the operator demonstrates that physical change(s) led to a change in capacity of at least 10%*

The following condition needs to be fulfilled to claim a significant capacity change:

In case of capacity increases:  $\frac{C_{new}}{C_{initial}} \geq 1.10$

In case of capacity decreases:  $\frac{C_{new}}{C_{initial}} \leq 0.90$

With:

- $C_{initial}$ : the initial installed capacity of the sub-installation *until the month of the physical change (see Chapter 5). In case of more than one physical change leading to incremental capacity changes, the first physical change should be considered as reference for the initial capacity.*
- $C_{new}$ : the new capacity defined as the average of the 2 highest monthly activity levels within the first 6 months following the start of changed operation determining the capacity of the sub-installation after the change.

The way to determine the start of changed operation ( $D_1$ ) is described below:

*Step I.* The operator establishes:

- a. in case of capacity extensions; the added design capacity ( $C_{added, design}$ ) (see Figure 6).
- b. in case of capacity reductions; the remaining design capacity ( $C_{remaining, design}$ ).  
The remaining design capacity is the design capacity that will remain after the reduction in capacity (see Figure 6).

The design capacity needs to be determined on the basis of project documentation and on the guaranteed values given by the supplier. Relevant documents could be reports -the ones accompanying the project-, datasheets, guaranteed performance values. The design capacity is solely used for the determination of the start of changed operation (and not to determine the added capacity used to calculate any allocation).

*Step II.* In case of capacity extensions; from the physical change onwards, the operator should determine the activity level related to the added design capacity ( $AL_{added, design}$ ) at a daily basis<sup>7</sup>:

- When possible, the activity level will be based on physically added capacity: e.g. when the capacity extension consists of a new production line, the activity level related to the added design capacity is the production of the new production line.
- Some capacity extensions will be of modifications to existing equipment. It may then be difficult for the operator to provide the required activity level data related to the added design capacity only. In such cases, the activity level attributed to the added capacity is determined by the total activity level

---

<sup>7</sup> In exceptional cases where the operator demonstrates that no daily activity data are available, monthly data could be accepted to determine the start of changed operation.

( $AL_{total}$ ) minus the average activity level in calendar years prior to the physical change:

$$AL_{added,design} = AL_{Total} - AL_{average}$$

In case of capacity reductions, given that usually no start up phases is needed to optimize the physical change within the production process, the operator should determine the total activity level at a daily basis from the physical change onwards.

- Step III.* The operator determines the earliest continuous 90 days period during which,
- in case of capacity extensions, the activity level – aggregated over the 90 days period - related to the added design capacity is at least 40% of the added design capacity

$$AL_{added,design} \geq 0.4 \times C_{added,design}$$

- in case of capacity reductions, the activity level – aggregated over the 90 days period - is at least 40% of the remaining design capacity

$$AL_{total} \geq 0.4 \times C_{remaining,design}$$

The start of changed operation ( $D_1$ ) is the first day of this period (for more details on the determination of the start of changed operation see explanations on the start of normal operation in section 6.3 which apply analogously).

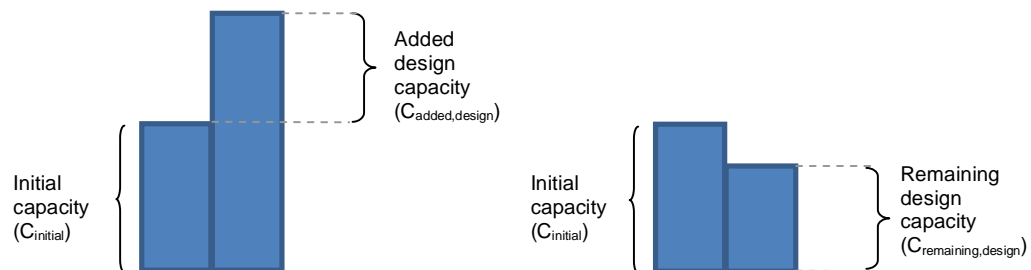

**Figure 6. Added design capacity (left) and remaining design capacity (right)**

#### Notes

*a- the capacity after the change cannot be determined by an experimental verification (as foreseen for the initial installed capacity prior to the extension in case no information on the highest activity levels is available).*

*b- De-bottlenecking is also covered by the rule for capacity changes: A small physical change does not lead to a significant change in capacity, but after a series of such small physical changes, the capacity increase might be considered as significant (if the 10% criteria is met). The start of changed operation is calculated as described above.*

*Possibility 2: The operator demonstrates that the physical change(s) led to a change in allocation to the sub-installation of more than 50 000 allowances and the difference represents more than 5% of the amount of allowances calculated irrespective of the physical change*

To apply this alternative, the operator will first have to determine the preliminary amount of free allowances (i.e. ignoring all correction factors) based on the historical activity level of the sub-installation irrespective of (i.e. ignoring) the physical change (i.e. taking median values 2005-2008 or 2009-2010).

The operator will then have to carry out a hypothetical calculation of the preliminary amount of free allowances using the methodology as described in Step 3.

Only if the difference between the two amounts of allowances is higher than 50 000 allowances and the difference represents more than 5% of the amount of allowances calculated irrespective of the physical change, the operator can consider that the sub-installation has had a significant capacity change.

If the abovementioned conditions are fulfilled, the sub-installation concerned has had a significant extension/reduction and the operator should apply for application of Article 9(9) taking into account the calculation methods explained in steps 2 and 3. In the other case, steps 2 and 3 do not apply.

#### **Step 2: Determination of the changed capacity of the sub-installation**

##### *Capacity extensions*

The added capacity is the difference between the new and initial capacity (see Figure 7):

$$C_{added} = C_{new} - C_{initial}$$

The initial capacity ( $C_{initial}$ ) has to be re-calculated as the average of the two highest monthly activity levels prior to the start of changed operation.

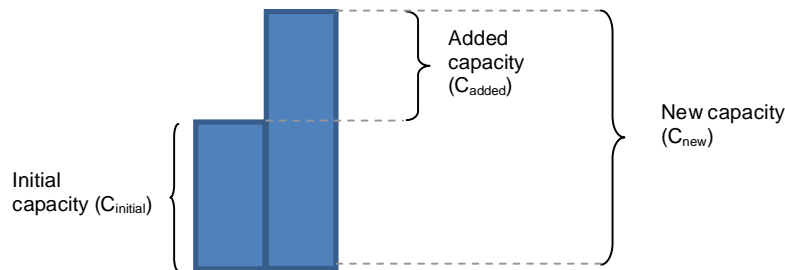
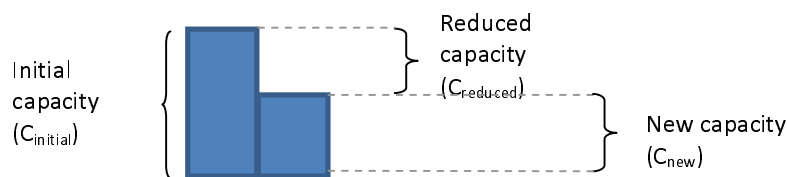

**Figure 7. Initial, added and new capacity**

### *Capacity reductions*

The reduced capacity is the difference between the initial and the new capacity (see Figure 8):

$$C_{reduced} = C_{initial} - C_{new}$$



**Figure 8. Initial, reduced and new capacity**

If possibility 1 in step 1 was the reason for the 'significant capacity extension/reduction', then the new capacity has already been calculated in step 1b.

If possibility 2 in the step 1 was the reason for the 'significant capacity extension/reduction', the new capacity still has to be calculated according to the same methodology as described in step 1b for possibility 1 (however the result can be less than 10%).

### **Step 3: Determination of the historical activity level**

Once the operator has determined that his sub-installation has indeed had a significant extension/reduction (step 1) and has determined the added/reduced capacity (step 2), the operator needs to determine the historical activity level of the sub-installation concerned in order to determine the preliminary amount of allowances.

The new historical activity level ( $HAL_{new}$ ) of sub-installations having had a significant change in capacity is determined on the basis of Article 9(9), and is equal to:



$$HAL_{new} = HAL_{initial} + HAL_{change}$$

Where:

$HAL_{initial}$  The historical activity level within the baseline period (either 2005-2008 or 2009-2010) related to the initial capacity.

$HAL_{change}$  The historical activity level related to the changed capacity.

Note that in case of significant capacity reductions, the value for  $HAL_{change}$  is negative. In case the absolute value for  $HAL_{change}$  exceeds the value for  $HAL_{initial}$  the new historical activity level is set to zero.

The determination of  $HAL_{initial}$  and  $HAL_{change}$  is described in the following paragraphs:

#### **$HAL_{initial}$ in case of capacity extensions**

In case of capacity extensions, the historical activity level related to the initial capacity is the median of annual historical activity levels relating to the initial capacity for the years in the baseline period (2005-2008 or 2009-2010):

$$HAL_{initial} = median_{baseline} (Annual\ activity\ levels\ related\ to\ the\ initial\ capacity)$$

For the period prior to the start of changed operation, the annual activity level related to the initial capacity is equal to the annual activity level of the relevant sub-installation. For the period after the significant extension (including the calendar year of the start of changed operation), the historical activity level referring to the initial capacity needs to be determined as follows:

- When possible, the activity level will be based on initial capacity: e.g. when the capacity extension consists of a new production line, the activity level related to the initial capacity is the activity level of the production lines that were already there before the extension.
- Some capacity extensions will be of modifications to existing equipment. It may then be difficult for the operator to provide the required activity level data related to the initial capacity only. In such cases, the activity level attributed to the initial capacity ( $AL_{initial}$ ) should be estimated by the initial capacity ( $C_{initial}$ ) times the historical capacity utilisation ( $HCUF_{initial}$ ):

$$AL_{initial} = C_{initial} \cdot HCUF_{initial}$$

#### **$HAL_{initial}$ in case of capacity reductions**

In case of capacity reductions, the historical activity level related to the initial capacity only exists prior to the physical change leading to the capacity reduction. Therefore, calendar years after the one of the start of changed operations should not be considered when calculating the historical activity level.

### **HAL<sub>change</sub> in case of capacity extensions**

The historical activity level of the added capacity is the product of the added capacity with the average historical capacity utilisation of the installation concerned of the years prior to the start of changed operation ( $HCUF_{initial}$ ).

$$HAL_{change} = C_{added} \times HCUF_{initial}$$

The average historical capacity utilisation  $HCUF_{initial}$  is to be determined by dividing the average of the activity levels of all full calendar years prior to the relevant physical change leading to the (first) significant capacity extension by the initial installed capacity.

$$HCUF_{initial} = (\text{average annual production prior to change}) / C_{initial}$$

For significant extensions in 2005, the calculation of the average historical capacity utilisation should be based on monthly data.

The  $HCUF_{initial}$  is calculated at sub-installation level.

The average historical capacity utilisation  $HCUF_{initial}$  is only calculated once and might be applied to more than one significant capacity change.

In case the initial capacity is zero (new sub-installation), instead of the average historical capacity utilisation, a relevant capacity utilisation factor should be established by the CA based on information provided by the operator (see section 6.3).

### **HAL<sub>change</sub> in case of capacity reductions**

In case of capacity reductions, the historical activity level related to the reduced capacity is calculated similar to the one for the added capacity:

$$HAL_{change} = -1 \times C_{reduced} \times HCUF_{initial}$$

### **Example 1: capacity increase on 20<sup>th</sup> June 2007**

In this example, an installation has had one capacity extension on 20<sup>th</sup> June 2007.

Initial capacity of the installation:  $C_{initial} = 1200$  (based on the 2 highest months prior to change)

Installed capacity after the extension:  $C_{new} = 1800$  (based on the 2 highest months within 6 months after the start of changed operation)

Added capacity:  $C_{add} = C_{new} - C_{initial} = 600$

Year	2005	2006	2007	2008
Total activity level (P)	1000	1000	1250	1800

*Step A: Determine production related to initial capacity*

Year	2005	2006	2007	2008
<b>Capacity</b>				
Initial capacity ( $C_{initial}$ )	1200	1200	1200	1200
added capacity ( $C_{add1}$ )			600	600
Total capacity ( $C_{total}$ )	1200	1200	1800	1800
<b>Activity level</b>				
Total activity level (P)	1000	1000	1250	1800
Activity level relating to $C_{initial} = C_{initial} \times HCUF_{initial}$	1000	1000	1000	1000

*Step B: Determine  $HAL_{initial}$*

From this production data  $HAL_{initial}$  is calculated by taking the median of the years in the baseline period excluding the year in which the start of changed operation took place:

$$HAL_{initial} = \text{median}_{2005, 2006, 2007, 2008}(\text{activity level relating to } C_{initial}) = 1000$$

*Step C: Determine  $HCUF_{initial}$*

$$HCUF_{initial} = (\text{average yearly activity level in calendar years prior to change}) / C_{initial} = 1000 / 1200$$

*Step D: Determine  $HAL_{change}$*

$$HAL_{change} = C_{add} \times HCUF_{initial} = 600 \times 1000 / 1200 = 500$$

*Step E: Determine  $HAL_{new}$*

$$HAL_{new} = HAL_{initial} + HAL_{change} = 1000 + 500 = 1500$$

### **Example 2: capacity reduction on 20<sup>th</sup> June 2007**

In this example, an installation has had one capacity reduction on 20<sup>th</sup> June 2007.

Initial capacity of the installation:	$C_{initial} = 1200$ (based on the 2 highest months prior to the change)
Installed capacity after the reduction:	$C_{new} = 600$ (based on the 2 highest months within 6 months after the start of changed operation)
Reduced capacity:	$C_{reduction} = C_{new} - C_{initial} = -600$

Year	2005	2006	2007	2008
Total activity level (P)	1000	1000	600	500

*Step A: Determine production related to initial capacity*

Year	2005	2006	2007	2008
<b>Capacity</b>				
New capacity ( $C_{new}$ )			600	600
Reduced capacity ( $C_{red}$ )			600	600
Initial capacity ( $C_{initial}$ )	1200	1200	1200	
<b>Activity level</b>				
Total activity level (P)	1000	1000	600	500
Activity level relating to $C_{initial}$	1000	1000	600	

*Step B: Determine  $HAL_{initial}$*

From this production data  $HAL_{initial}$  is calculated by taking the median of the years in the baseline period excluding the year after the one in which the start of changed operation took place:

$$HAL_{initial} = \text{median}_{2005, 2006, 2007}(\text{activity level relating to } C_{initial}) = 1000$$

*Step C: Determine  $HCUF_{initial}$*

$$HCUF_{initial} = (\text{average yearly activity levels in calendar years prior to change}) / C_{initial} = 1000 / 1200$$

*Step D: Determine  $HAL_{change}$*

$$HAL_{change} = -1 \times C_{red} \times HCUF_{initial} = -1 \times 600 \times 1000 / 1200 = -500$$

*Step E: Determine  $HAL_{new}$*

$$HAL_{new} = HAL_{initial} + HAL_{change} = 1000 - 500 = 500$$

### **Example 3: Two significant capacity extensions during the baseline period**

In this example, an installation has had two capacity extensions during the baseline period: one on 1<sup>st</sup> January 2006, the second on 1<sup>st</sup> April 2007 (see Figure 9 illustrating the capacity changes).

Initial capacity of the installation:

$$C_{initial} = 100 \quad (\text{based on the 2 highest months prior to the change})$$

Installed capacity after the first extension:

$$C_{new1} = 180 \quad (\text{based on the 2 highest months within 6 months after the change})$$

First added capacity:

$$C_{add1} = C_{new1} - C_{initial} = 80$$

Installed capacity after the second extension:  $C_{new2} = 230$  (based on the 2 highest months within 6 months after the change)  
 Second added capacity:  $C_{add2} = C_{new2} - C_{new1} = 50$

Year	2005	2006	2007	2008
Total activity level (P)	95	170	200	225

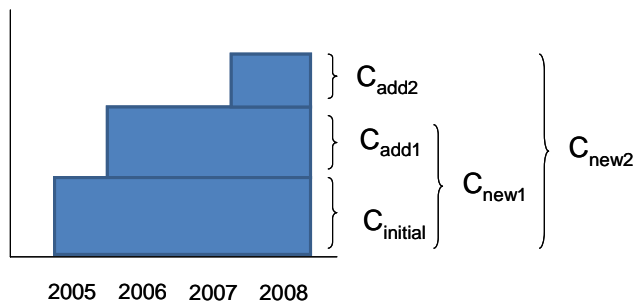

Figure 9. Two significant capacity extensions

Step A: Determine production related to initial capacity

Year	2005	2006	2007	2008
<b>Capacity</b>				
Initial capacity ( $C_{initial}$ )	100	100	100	100
1 <sup>st</sup> added capacity ( $C_{add1}$ )		80	80	80
2 <sup>nd</sup> added capacity ( $C_{add2}$ )			50	50
Total capacity ( $C_{new}$ )	100	180	230	230
<b>Activity level</b>				
Total activity level (P)	95	170	200	225
Activity level relating to $C_{initial} = C_{initial} \times HCUF_{initial}$	95	95	95	95

Step B: Determine  $HAL_{initial}$

From this production data  $HAL_{initial}$  is calculated as follows:

$$HAL_{initial} = \text{median}_{2005-2008}(\text{production relating to } C_{initial}) = 95$$

Step C: Determine  $HCUF_{initial}$

$$HCUF_{initial} = (\text{average yearly activity levels prior to change}) / C_{initial} = 95 / 100$$

Note that in the determination of  $HCUF_{initial}$ , the values for 2005 are taken into account.

Step D: Determine  $HAL_{change1}$  and  $HAL_{change2}$

$$HAL_{change1} = C_{add1} \times HCUF_{initial} = 80 \times 95/100 = 76$$

$$HAL_{change2} = C_{add2} \times HCUF_{initial} = 50 \times 95/100 = 47.5$$

*Step E: Determine  $HAL_{new}$*

$$HAL_{new} = HAL_{initial} + HAL_{change1} + HAL_{change2} = 95 + 76.0 + 47.5 = 218.5$$

## 7 Additional examples

This chapter provides some additional examples to illustrate the calculation of allocation to installations.

### 7.1 Example 1: Installation without product benchmarks and with different carbon leakage statuses

Consider the following installation which produces three products (A, B, and C) of which A and B are deemed to be exposed to a significant risk of carbon leakage, and C is not.

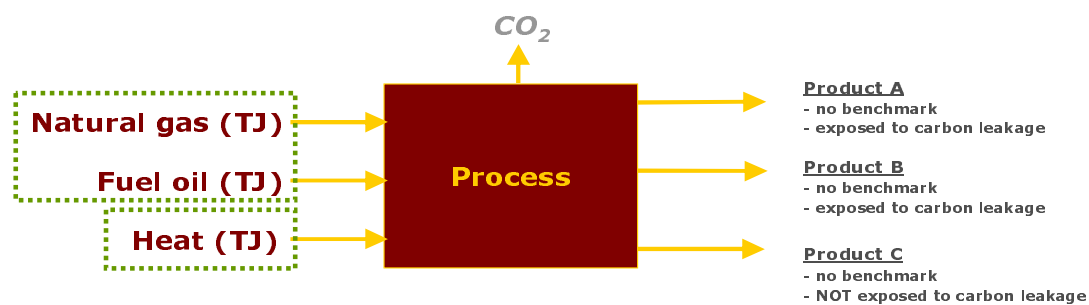

Figure 10 How many sub-installations are present in this installation?

Since the products A, B, and C do not have a product benchmark applicable, the fall-back approaches should be used. In case no eligible process emissions arise, then only heat and fuel benchmarks should be used. As the Carbon Leakage status is not the same for all the products, there will be four sub-installations in total.

1. Heat benchmark for products deemed exposed to Carbon Leakage (A and B);
2. Heat benchmark for products not deemed exposed to Carbon Leakage (C);
3. Fuel benchmark for products deemed exposed to Carbon Leakage (A and B);
4. Fuel benchmark for products not deemed exposed to Carbon Leakage (C).

To calculate the historical activity level of each installation, only the share of heat (resp. fuel) necessary to produce the relevant product(s) should be taken into account:

- HAL of sub-installation 1 should be based only on the measurable heat consumed to produce products A and B;
- HAL of sub-installation 2 should be based only on the measurable heat consumed to produce product C;
- HAL of sub-installation 3 should be based only on the fuel combusted to produce products A and B excluding fuel combustion for the production of measurable heat
- HAL of sub-installation 4 should be based only on the fuel combusted to produce product C, excluding fuel combustion for the production of measurable heat

For guidance on data to be used, see *Guidance Document 3 on data collection*.

## 7.2 Example 2: Combined heat and power (CHP)

In the case of a CHP installation (see Figure 11), the installation produces both heat and electricity:

- The production of electricity is not eligible for free allocation.
- The production of heat is eligible for free allocation:
  - The CHP installation will not receive any free allocation for the part of the heat that goes to an **ETS consumer**, as the ETS heat consumer will receive the free allowances for the heat it consumes.
  - The CHP installation will receive free allocation according to the heat benchmark for the heat exported to **non-ETS consumers**, and for the heat consumed at the installation, when this heat is not used to produce electricity. Only this part of the heat should be taken into account when determining the historical activity level relevant for the heat benchmark sub-installation of the CHP.
- No calculations are needed to split the emissions from a CHP over heat and electricity production. An exception to this rule is the allocation in case of **heat export to private households** (See *Guidance Document 6 on cross-boundary heat flows* for more guidance on this topic)

By default, non-ETS consumers are not deemed to be exposed to a risk of carbon leakage. In case the CHP operator is able to prove that one of his non-ETS heat consumers is deemed to be exposed to a risk of carbon leakage, he may need to split the sub-installation into 2 heat benchmark sub-installations: one for the non-ETS heat consumers that are deemed to be exposed to a risk of carbon leakage, and one for the non-ETS consumers who are not deemed to be exposed.

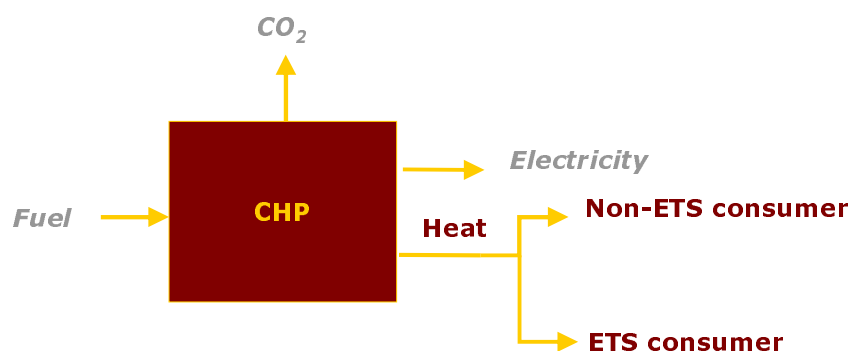
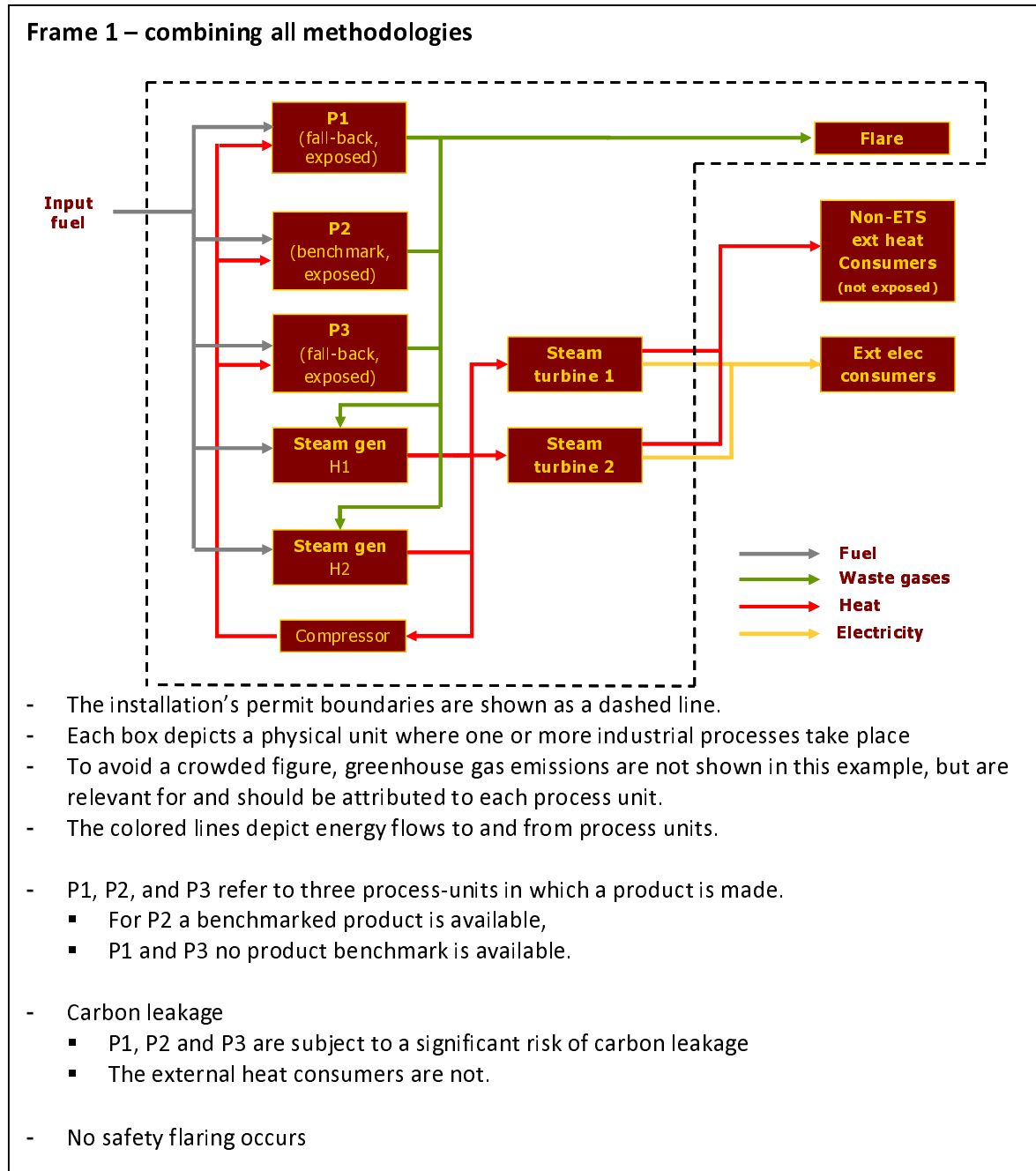

Figure 11

Schematic diagram of CHP installation



### 7.3 Example 3: Complex example



## Frame 2 – product benchmark

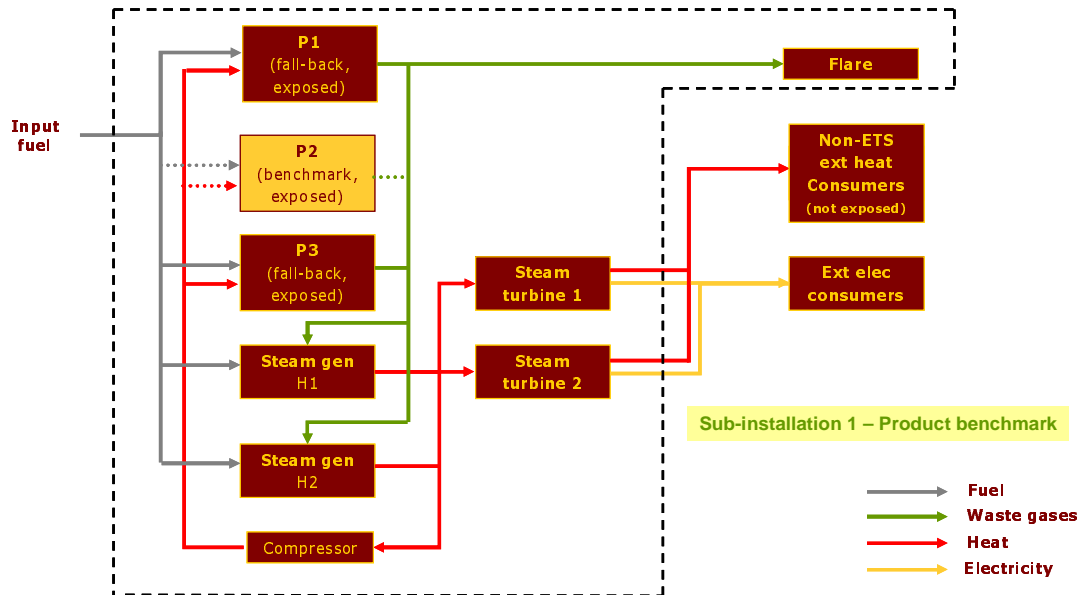

### *Step 1a: Definition of product benchmark sub-installations*

The installation has 1 product with a product benchmark (hence,  $n=1$ ). For the manufacture of this product, process unit P2 is identified.

### *Step 1b: Attribute relevant inputs and outputs*

- The relevant energy flows for sub-installation 1 are shown as dashed lines.
- In sub-installation 1 (P2) fuel and heat go in, waste gases and emissions (not shown) go out, and are attributed to the sub-installation.
- The amount of fuel and heat input (in units of energy) are not influencing the amount of free allocation to sub-installation 1, but are relevant to know because they should not be attributed to other sub-installations.

### *Step 1c: Determine historical activity level*

- Determination of the historical activity level of sub-installation 1 will be based on the historical production levels of product P2

### Frame 3 – heat benchmark; carbon leakage exposed

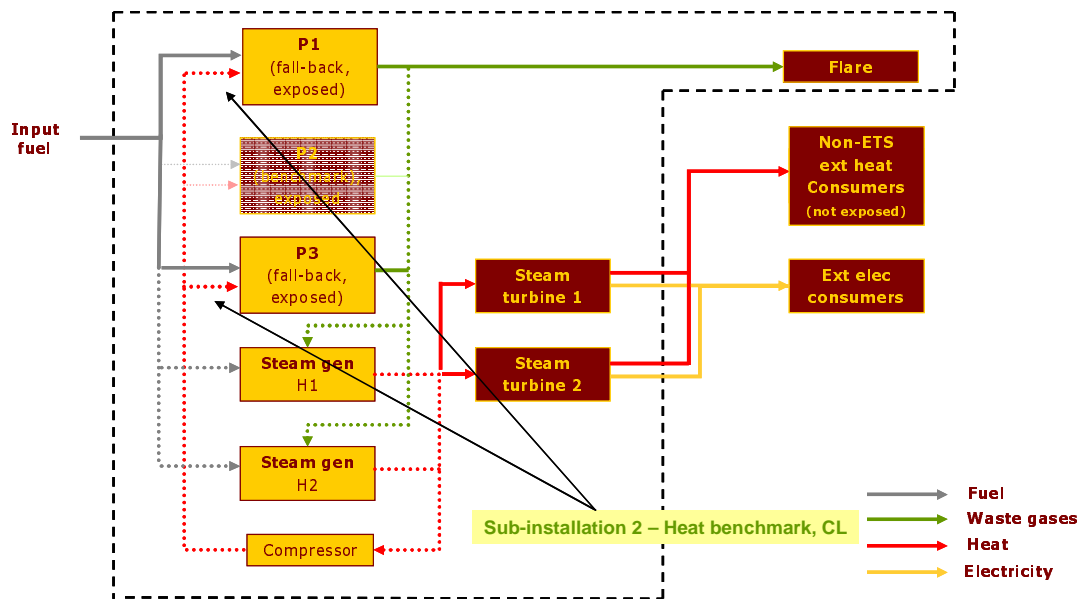

#### Step 2a Define one or two heat benchmark sub-installations

- The installation consumes measurable heat outside the boundaries of a product benchmark (P1 and P3) and exports heat to non-ETS consumers.
- The process units (P1 and P3) are exposed to a significant risk of carbon leakage, whereas the non-ETS consumers are not. Two heat benchmark sub-installations therefore need to be defined.

#### Step 2a and 2b, attribute relevant inputs and outputs (Sub-installation 2)

- Sub-installation 2 accounts for the heat consumed by P1 and P3, for the emissions linked to the production of this heat and for the energy flows used to produce this heat.
- The heat is produced by the combustion of waste gases and fuel in the 2 steam generators; part of the produced heat is also consumed by other consumers. Sub-installation 2 therefore accounts for part of the waste gases and fuel combusted in the steam generators, and for part of the corresponding emissions

#### Step 2c Determine historical activity level (Sub-installation 2)

- The Historical Activity Level of sub-installation 2 will be based on the sum of the heat consumed by P1 and P3.

#### Frame 4 – heat benchmark; non carbon leakage exposed

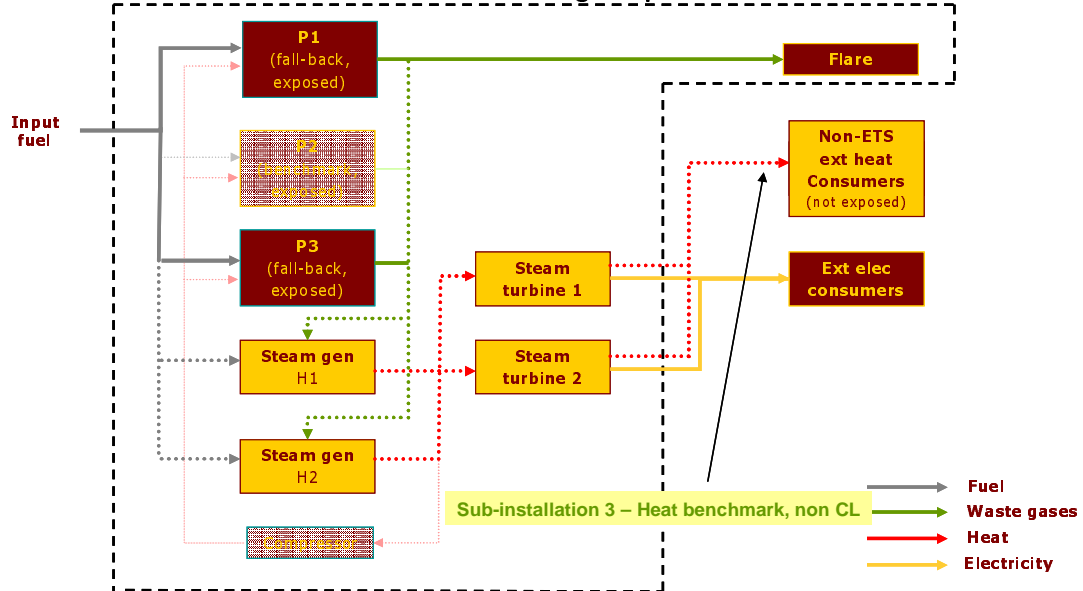

#### Step 2a and 2b, attribute relevant inputs and outputs (Sub-installation 3)

- Sub-installation 3 will be defined for the production of measurable heat, consumed for the production of products *not* deemed exposed to a significant risk of Carbon Leakage. In this example the consumers are non-ETS, and the allocation is therefore given to the producer of the heat (as no allocation can be given to a non-ETS plant).

*If the external heat consumer was another ETS-installation, the free allocation would be given to the heat consumer, and therefore this sub-installation would not be part of the current installation.*

- As for sub-installation 2, sub-installation 3 accounts for part of the waste gases and fuel combusted in the steam generators, and for part of the corresponding emissions (looking only at the “consumer part” of the emissions from the waste gases – see Guidance Document 8 for additional guidance). Sub-installations 2 and 3 together cover the total amount of fuels used to generate the measurable heat and the corresponding emissions

#### Step 2c Determine historical activity level (Sub-installation 3)

The Historical Activity Level of sub-installation 3 will be based on the heat exported to the non-ETS consumers.

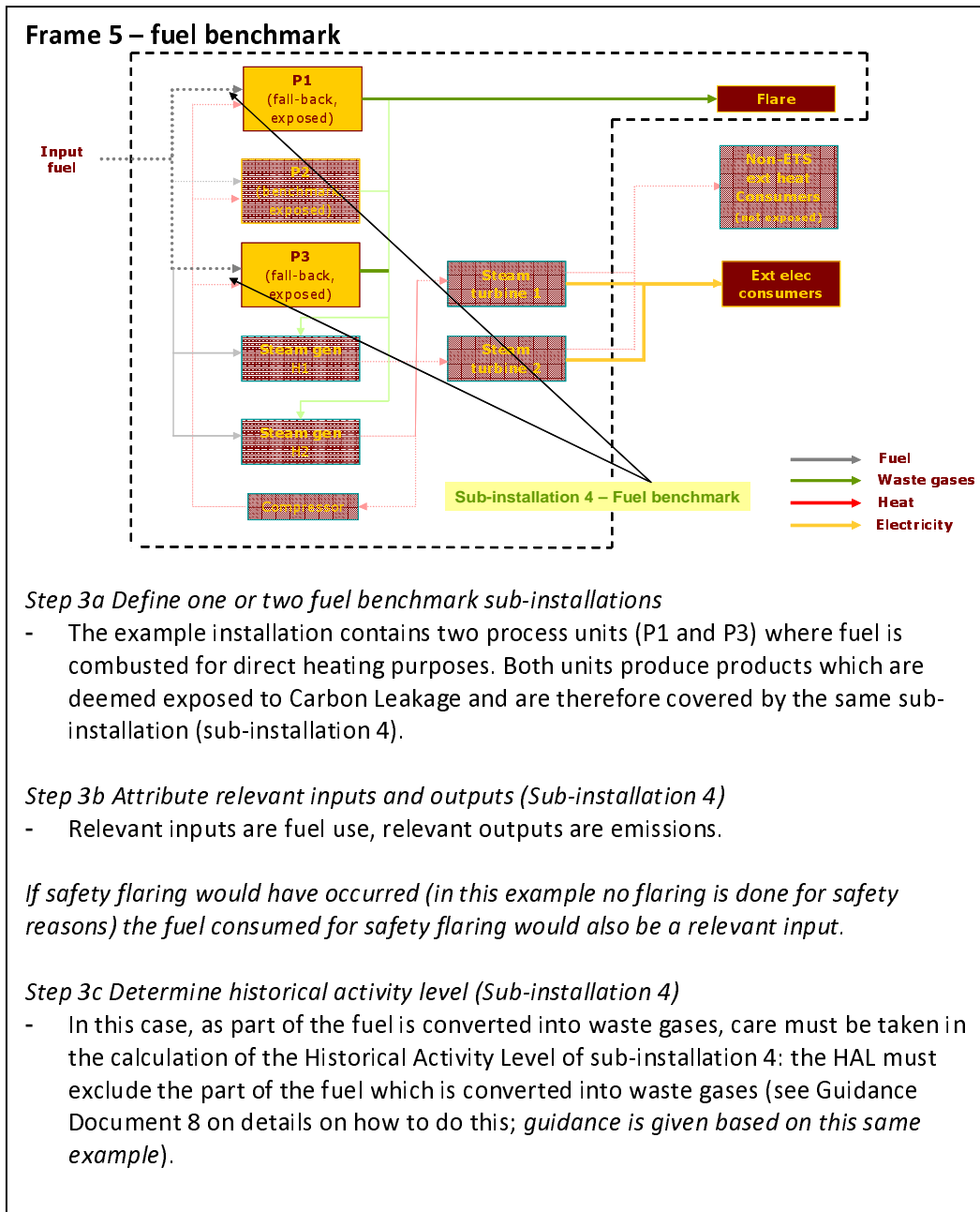

## Frame 6 – historical emissions for process emissions

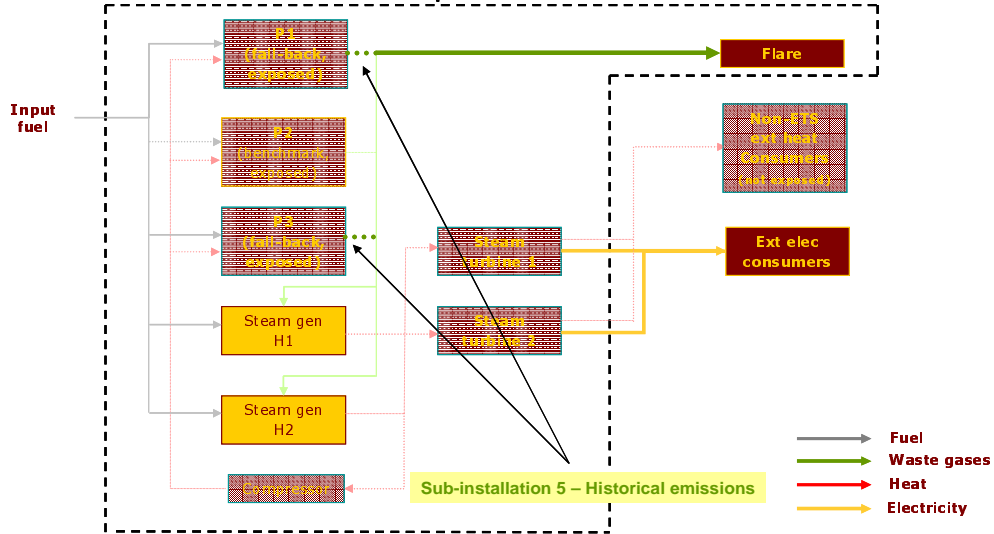

### Step 4a Define one or two process emissions sub-installations

- In our example plant, waste gases produced by P1 and P3 can be either flared (not for safety reasons) or used for combustion in the steam generators.
- Flaring (other than safety flaring) is not eligible for free allocation, and the use of waste gases in the steam generators has been covered by the 2 heat benchmarks (frames 3 and 4).
- Hence, sub-installation 5 is defined using the historical emissions approach for the production of the waste gases from P1 and P3, and the relevant stream to attribute is the stream of waste gases produced.

### Step 3b Attribute relevant inputs and outputs (Sub-installation 5)

Relevant inputs and outputs are:

- The amount of CO<sub>2</sub> in the waste gas
- The amount of incompletely combusted carbon in the waste gas
- The energy content of the waste gas
- The fuel needed to produce the waste gas

### Step 3c Determine historical activity level (Sub-installation 5)

The historical activity level would be the CO<sub>2</sub> emissions plus the emissions stemming from the combustion of incompletely combusted carbon in the waste gases MINUS the emissions from the combustion of an amount of natural gas with the same energy content. Note that the allocation for waste gas use goes to the consumer of the waste gas and not to the producer. This is not relevant in this example as the waste gas is both produced and consumed in the same installation. For additional guidance on allocation for emissions from waste gases, see Guidance Document 8.

## Frame 7 – non-eligible emissions

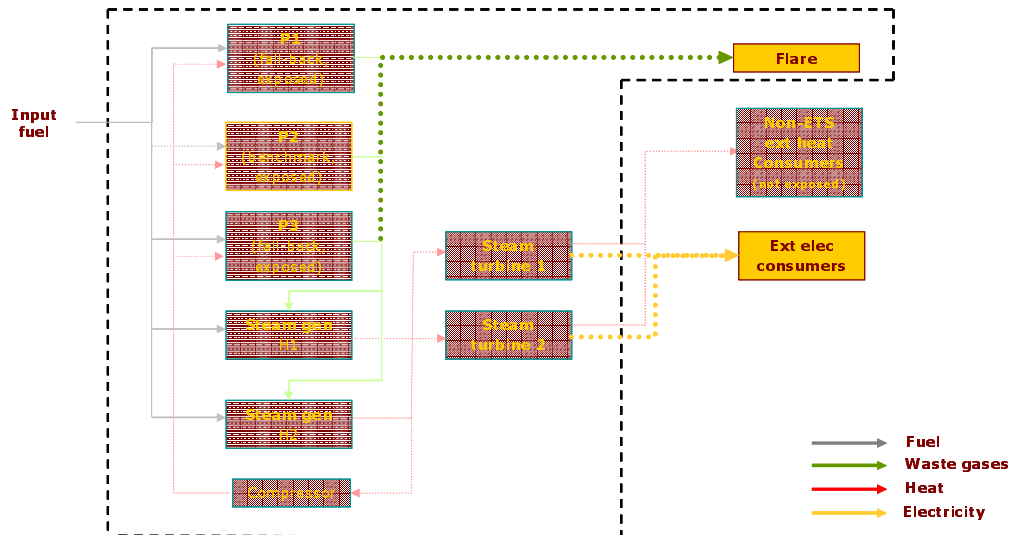

The last part of the sub-installation exercise is to attribute non-eligible emissions, i.e. emissions caused by electricity production or flaring other than safety flaring. As these emissions are not eligible for free allocation, there is no sub-installation needed for these emissions. Rather they are attributed as memo items in the full list of activities and emissions.

At this stage, the operator should check that all identified sources (such as energy inputs and emissions) have been either attributed to a sub-installation or are listed in the non-eligible section; each (part of a) source can only be attributed once.